

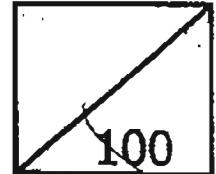

**Rosyth School**  
**Preliminary Examination for 2011**  
**STANDARD SCIENCE**  
**Primary 6**



Name: \_\_\_\_\_

Total  
Marks:

Class: Pr \_\_\_\_\_ Register No. \_\_\_\_\_

Duration: 1 h 45 min

Date: 25 August 2011

Parent's Signature: \_\_\_\_\_

Instructions to Pupils:

1. Do not open the booklets until you are told to do so.
2. Follow all instructions carefully.
3. This paper consists of 2 booklets, Booklet A and Booklet B.
4. For questions 1 to 30 in Booklet A, shade the correct ovals on the Optical Answer Sheet (OAS) provided using a 2B pencil.
5. For questions 31 to 44, give your answers in the spaces given in the Booklet B.

	<b>Maximum</b>	<b>Marks Obtained</b>
<b>Booklet A</b>	<b>60 marks</b>	
<b>Booklet B</b>	<b>40 marks</b>	
<b>Total</b>	<b>100 marks</b>	

\* This booklet consists of 19 pages .

This paper is not to be reproduced in part or whole without the permission of the Principal.

**PART I (60 marks)**

For each question from 1 to 30, four options are given. One of them is the correct answer. Make your choice (1, 2, 3 or 4). **Shade the correct oval (1, 2, 3 or 4) on the Optical Answer Sheet.**

1 The flow chart below shows how some animals are classified.

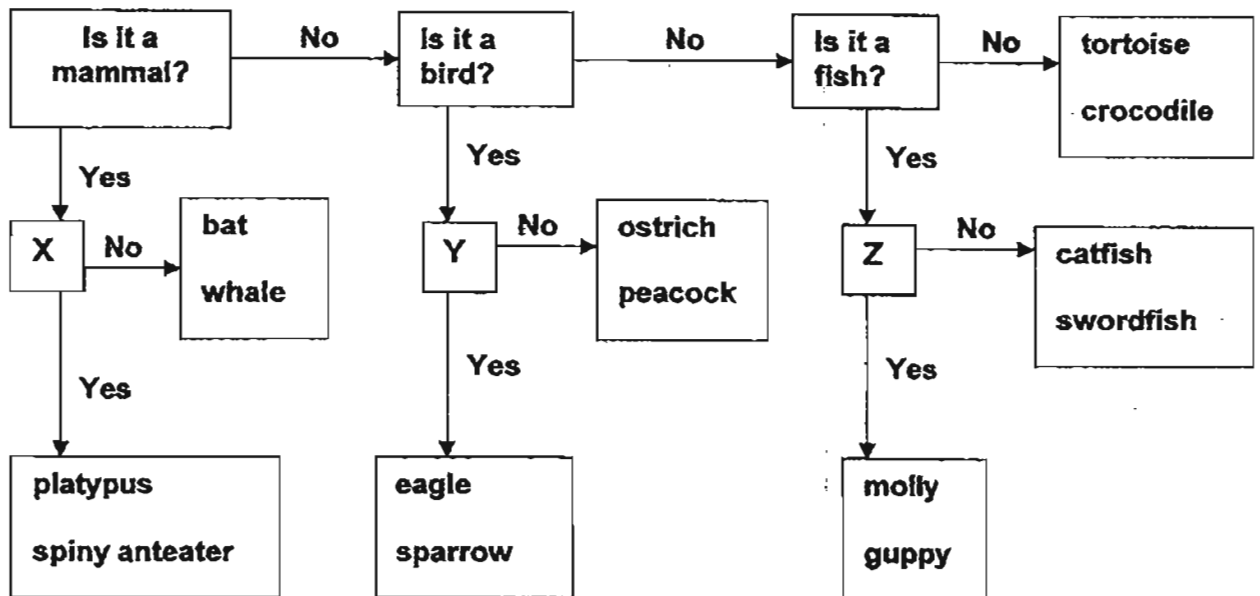

X, Y and Z each represents a different question that helps to classify the animals.

Which one of the following best represent X, Y and Z?

	X	Y	Z
(1)	Does it live on land?	Does it have wings?	Does it have scales?
(2)	Does it lay eggs?	Can it fly?	Does it give birth?
(3)	Does it have hair?	Does it have a beak?	Does it lay eggs?
(4)	Does it give birth?	Can it swim?	Does it live in fresh water?

2 Mandy wanted to find out if mould grew faster on wholemeal or white bread. She placed a moist piece of white bread and a moist piece of wholemeal bread, both of the same size, in separate sandwich bags. She put the bags under a lamp and checked for new mould growth every six hours.

What was the purpose of the lamp?

- (1) To provide enough light                      (2) To keep the surrounding dry  
 (3) To provide a warm temperature            (4) To enable the mould to make food

- 3 The following flow diagram shows several processes occurring in most organisms.

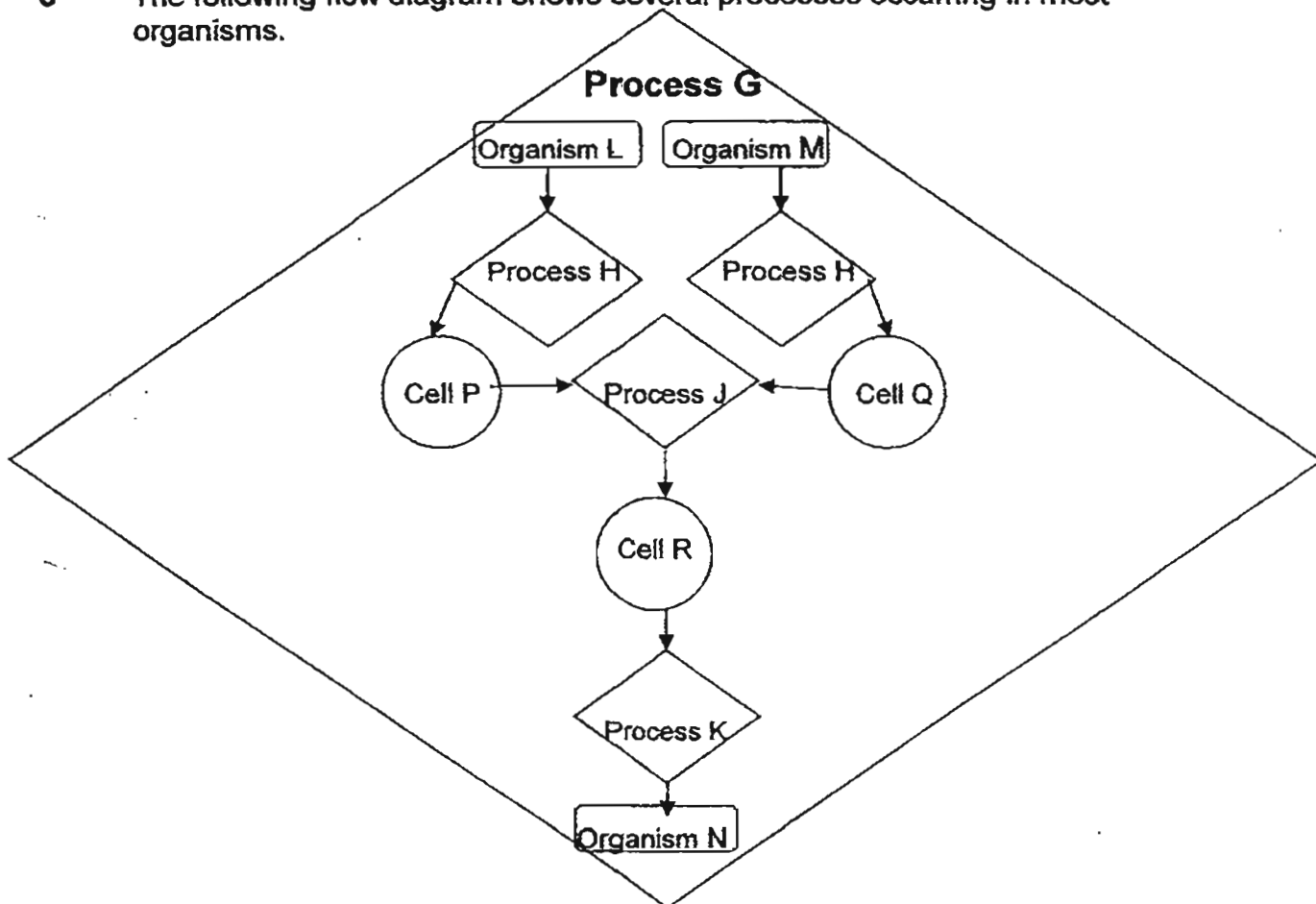

Which of the following identify Process G, Process J, Cell P and Cell Q?

	Process G	Process J	Cell P	Cell Q
(1)	fertilisation	reproduction	ovule	pollen
(2)	cell division	giving birth	ovum	sperm
(3)	giving birth	cell division	female	male
(4)	reproduction	fertilisation	female sex cell	male sex cell

- 4 Some of the events which occur during sexual reproduction in a flowering plant are listed below.

- A: Male sex cell fuses with female sex cell
- B: Anthers split open
- C: Growth of pollen tube
- D: Pollen grain sticks to stigma
- E: Seed develops inside ovary

In which order do the above events take place?

- (1) B, D, C, A, E
- (2) C, B, D, E, A
- (3) D, B, A, E, C
- (4) D, B, C, A, E

5 The diagram shows the side view of a human reproductive system.

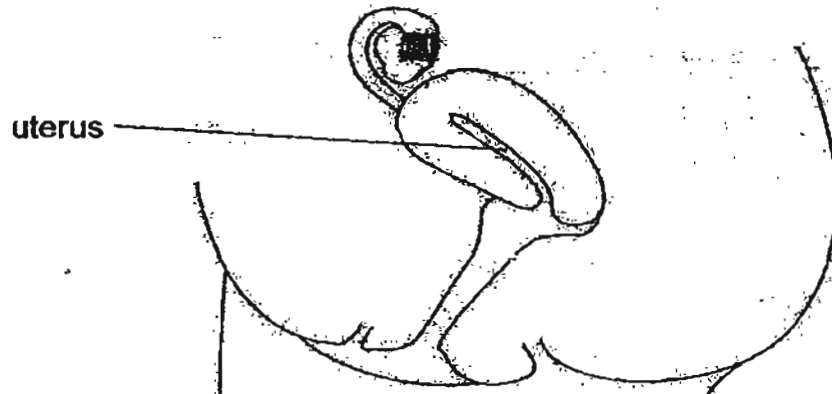

Which of the following occurs in the uterus?

- (1) Sperms are produced
- (2) Sperms are deposited
- (3) Eggs are produced
- (4) An unborn baby grows

6 An amoeba had its nucleus removed by means of a fine glass tube but it was not damaged. For several days it continued to feed and move as shown below.



On the contrary, an intact amoeba, used as a control, reproduced twice in that time as shown below.

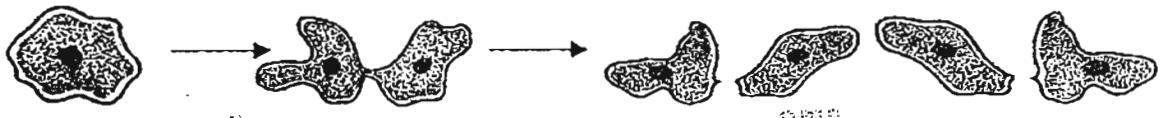

What can you conclude from the above experiment about the role of nucleus in amoeba?

- (1) The nucleus is essential for life.
- (2) The nucleus is essential for cell division.
- (3) The nucleus controls the normal activities of the cell.
- (4) The nucleus is the only part of the cell that contains DNA.

7 The diagram below shows the human digestive system.

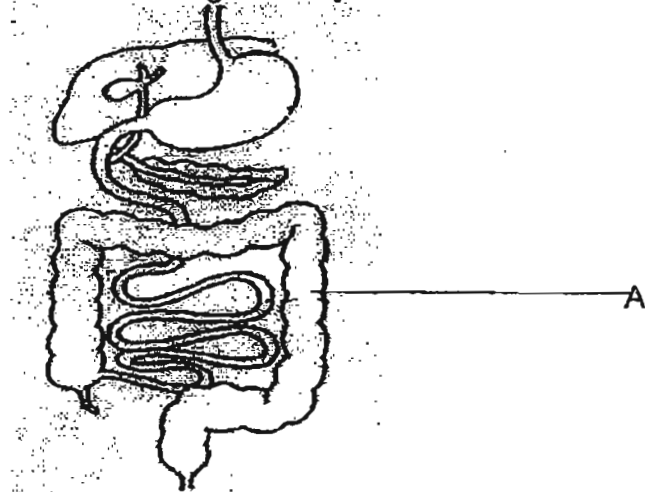

Which of the following takes place at the part labelled A?

- (1) storage of digested food
- (2) removal of urine
- (3) absorption of digested food
- (4) absorption of water

8 The diagram below shows how blood flows in the human body.

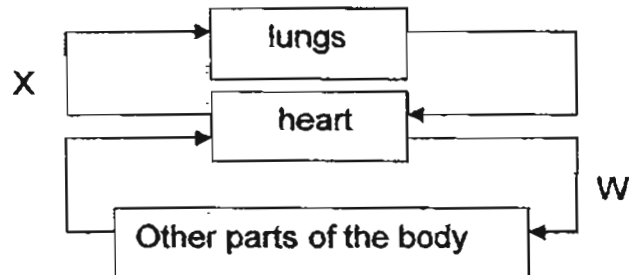

Blood samples were taken from blood vessels at W and X. The amount of dissolved oxygen in each of the blood samples was measured. The graph below shows the amount of dissolved oxygen in W. The amount of oxygen in X was not identified.

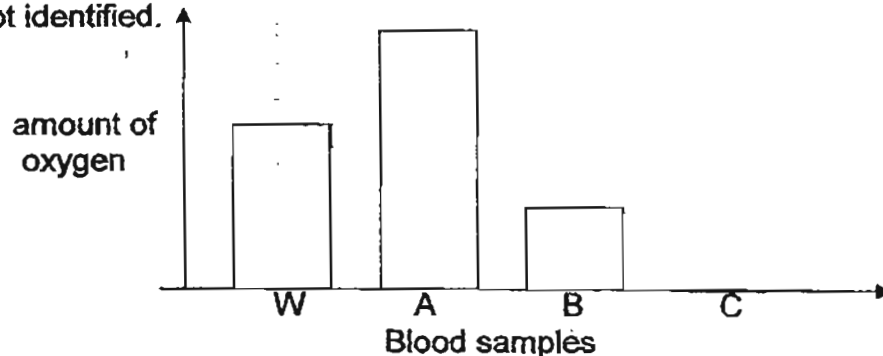

Which bar(s) would most probably represent the amount of oxygen in blood vessel X?

- (1) A only
- (2) B only
- (3) B and C only
- (4) A and C only

- 9 The diagram below shows a shoot of a plant used in a photosynthesis experiment. At the start of the experiment, there was no food detected on the leaves. At two places on the stem, Y and Z, tissues were removed.

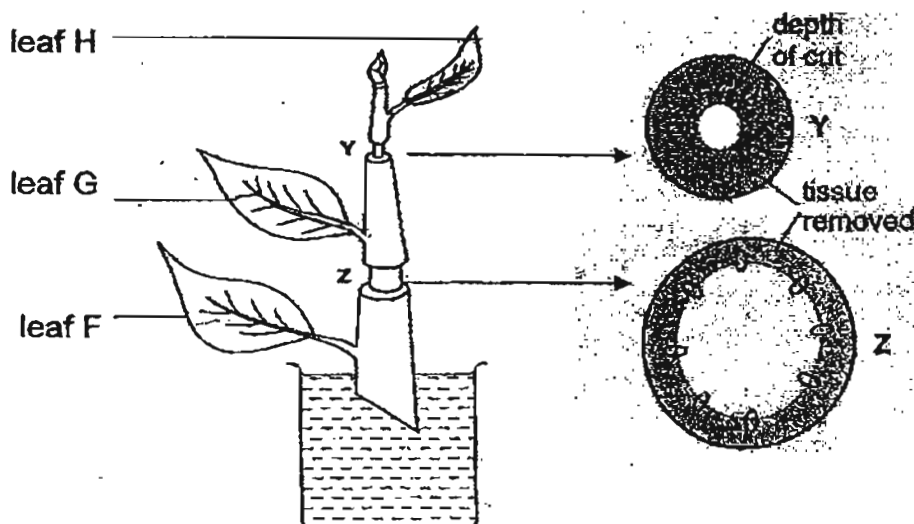

The plant was left in sunlight for six hours. After six hours, leaves F, G and H were tested for the presence of starch.

Which of the leaf/leaves turned iodine dark blue?

- (1) F only  
 (2) F and G only  
 (3) G and H only  
 (4) F, G and H
- 10 Which of the following characteristics of the environment is not correctly matched to how the organisms will be affected?

	Characteristics of the environment	Effect on the organisms
(1)	Drought	Dragonfly nymphs lose their habitat
(2)	Extreme heat	Plants lose too much water
(3)	Dry with lots of sunlight	Fungi obtain heat and multiply rapidly
(4)	Decrease in the population of plant eaters	Increase in competition among animal eaters for food

- 11 Mariam wanted to test four different types of soil. She set up the experiment as shown in the diagram. She measured the amount of water collected in the measuring cylinder after a certain period of time.

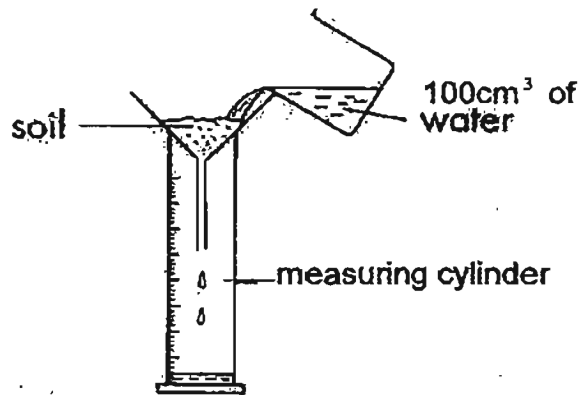

She recorded the results in the table below.

Type of soil	W	X	Y	Z
Amount of water (cm <sup>3</sup> )	34	81	75	97



The diagram above shows Plant Q growing in its natural habitat. Which soil is most suitable for Plant Q to grow?

- (1) W (2) X  
(3) Y (4) Z

- 12 Which of the following is a direct environmental effect when excess fertilisers are used?

- (1) Water pollution (2) Acid rain  
(3) Ozone Depletion (4) Global warming

- 13 The diagram below shows P, Q and R and S which are different varieties of the same species of fish. The fish live amongst water plants in a river.

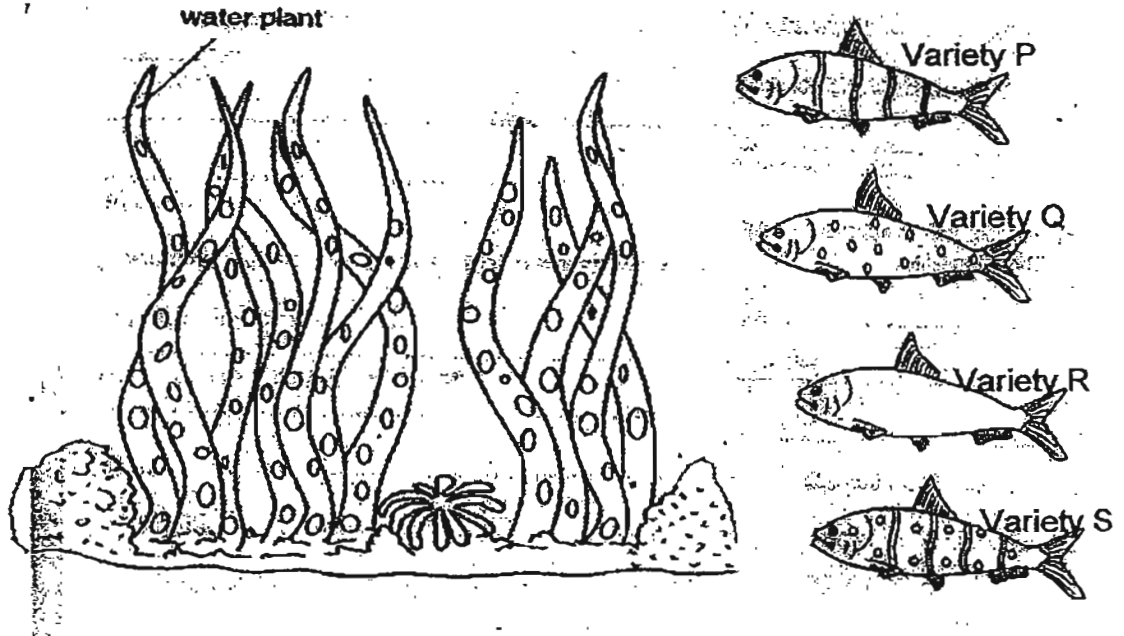

A predator of this species of fish, is introduced into the river.  
Which variety of fish would most likely decrease the greatest in number after some time?

- (1) P (2) Q  
(3) R (4) S

- 14 The diagram below shows four possible pathways for the transfer of energy from green plants to Man.

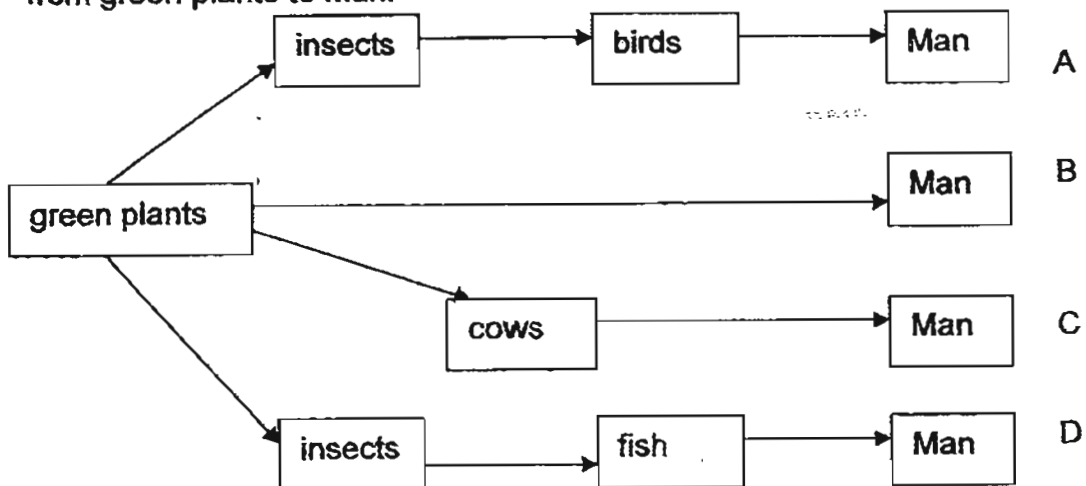

Which pathway transfers most energy to Man?

- (1) A (2) B  
(3) C (4) D



- 15 Some students wanted to test the effect of light on the production of oxygen by water plants.

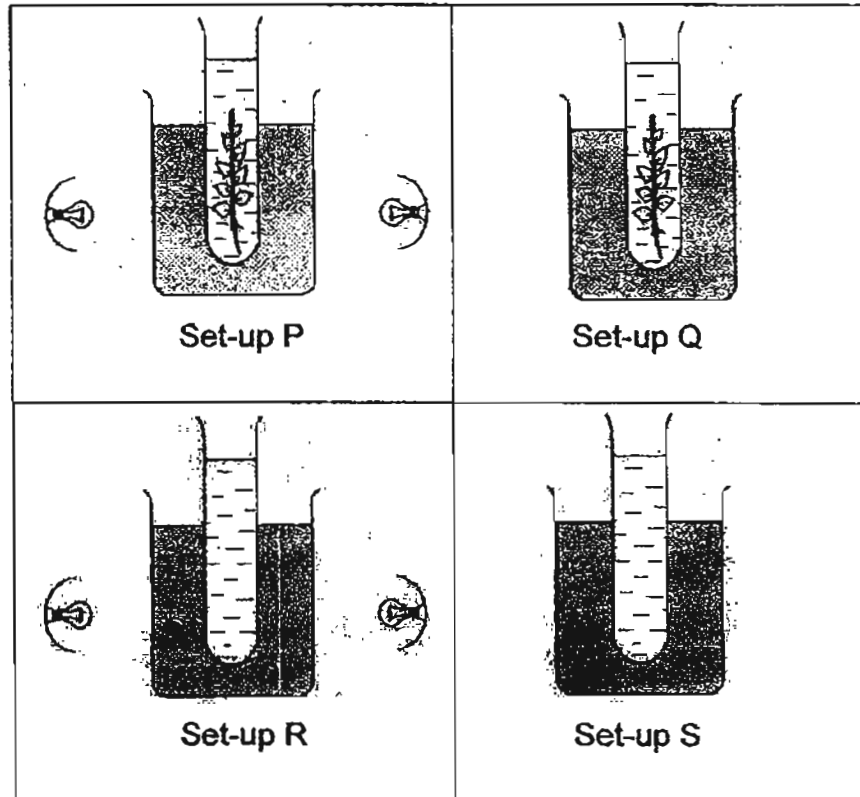

Which two of the above set-ups should be used in the experiment?

- (1) P and Q  
(2) P and S  
(3) Q and R  
(4) Q and S

- 16 Siew Lee made a plastic funnel using a plastic sheet and cut a hole at the bottom with scissors. She poured sand through the hole and measured the time taken for the sand to completely seep through the hole.

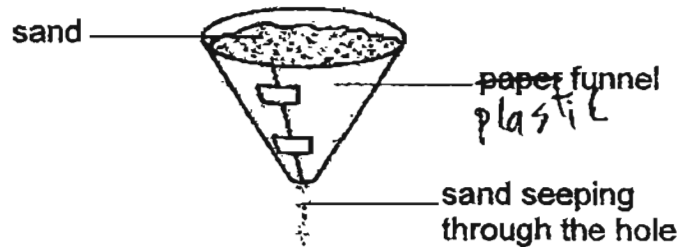

She repeated the experiment with varied sizes of the hole with the same material after which she tried the whole experiment with a styrofoam funnel, keeping all the rest of the variables the same. The results were then recorded in the table below.

Material of funnel	Size of the hole (mm)	Time taken for sand to seep through completely (s)
Plastic	2.0	46
Plastic	2.3	38
Plastic	2.7	30
Plastic	3.0	19
Plastic	3.2	7
Styrofoam	2.0	46
Styrofoam	2.3	38
Styrofoam	2.7	35
Styrofoam	3.0	23
Styrofoam	3.2	11

Based on the results above, which of the following statements observed from the experiment is correct?

- A: The type of materials used for the funnel affects the time taken for sand to seep through completely when the hole is smaller.
- B: The time taken for sand to seep through completely increases as the size of the hole decreases.
- C: The type of materials used for the funnel affects the time taken for sand to seep through completely only when the hole gets bigger.
- D: The smoother the funnel, the faster the sand seep through the funnel.

- (1) A and D only
- (3) B and D only

- (2) B and C only
- (4) B, C and D only

- 17 Wendy set up an experiment using four identical insulated cups. The diagram below shows her set-up at the start of the experiment.

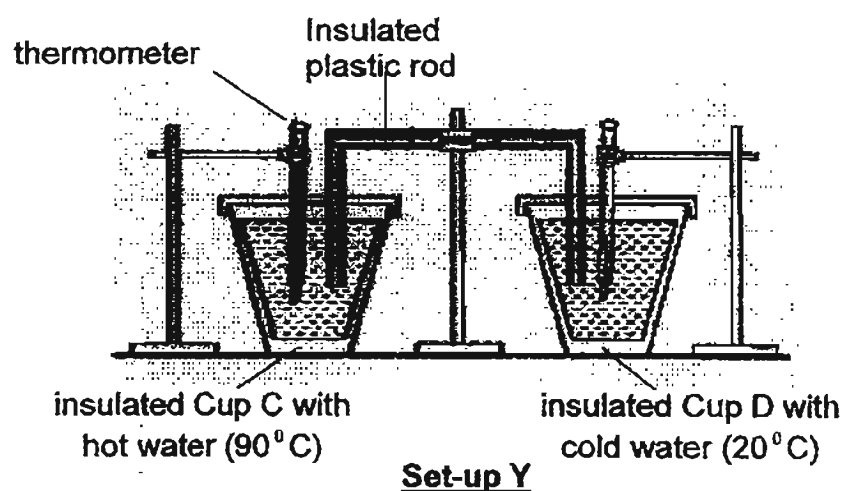
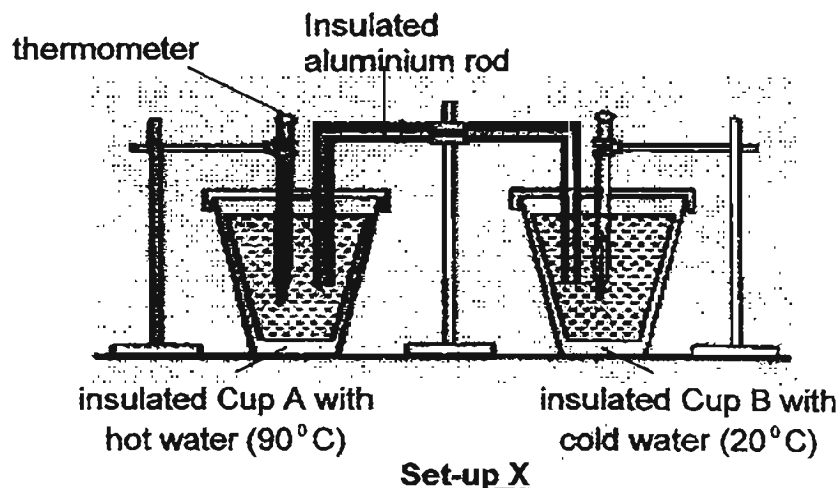

Five minutes after the experiment started, Wendy recorded the temperature of the water in each cup.

Which one of the following shows the temperature of the water from the coolest to the hottest after 5 minutes?

- (1) D, B, C, A
- (2) A, C, B, D
- (3) C, A, B, D
- (4) D, B, A, C

18 The table below shows the properties of two materials, X and Y.

X	Y
heavy weight	lightweight
will not melt under very high temperature	will melt under very high temperature
natural material	man-made material
absorbs water	waterproof

What materials are X and Y most likely to be?

	X	Y
(1)	Wood	Plastic
(2)	Glass	Aluminium
(3)	Sponge	Ceramic
(4)	Plastic	Rubber

19 The diagram below shows a toy which Azaya made in his free time. When the toy is released, it will roll on the floor. To make it roll again, he needs to 'wind' the toothpick again.

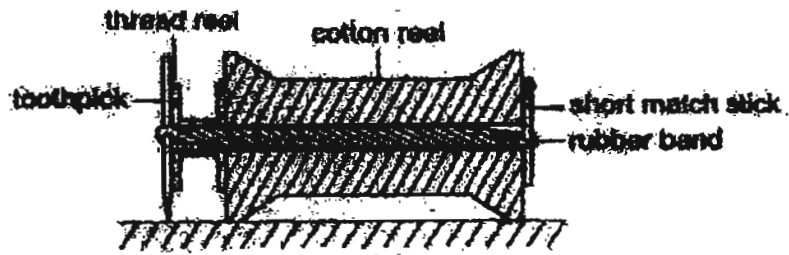

Which of the following variables should he increase in order to most effectively increase its kinetic energy?

- (1) The width of the cotton reel
- (2) The length of the toothpick
- (3) The elasticity of the rubber band
- (4) The number of turns the toy is wound

- 20 Wei Ming wanted to find out how much force was needed to overcome the attraction of different materials which were attracted to a strong magnet.

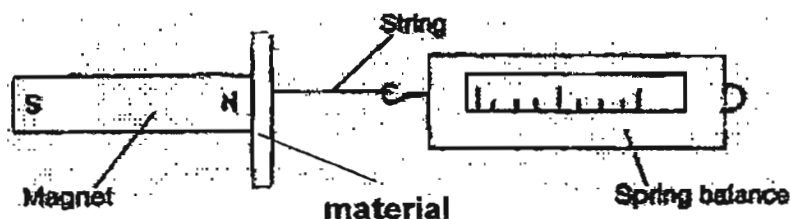

He pulled on the spring balance until the material was separated from the magnet. The readings on the spring balance were recorded as shown below.

Material	Readings on the Spring Balance (g)
P	45
Q	60
R	30
S	45

What conclusions could he make from the above activity?

- A: Q is the best material for magnetic attraction.  
 B: R is made from half a magnet of Q.  
 C: P and S are made from the same magnetic material.  
 D: R is least easily magnetized while Q is most easily magnetized by the magnet.

- (1) A only  
 (2) B and C only  
 (3) A and D only  
 (4) A, B, C and D

- 21 The following table shows the melting and boiling points of 4 liquids A, B, C and D.

	A	B	C	D
Melting point (°C)	-10.0	6.5	-7.2	25.6
Boiling point (°C)	36.1	80.7	58.8	82.6

Which one of them will evaporate fastest if placed in a room at 33°C?

- (1) A  
 (2) B  
 (3) C  
 (4) D

23 Dominic set up two glass jars as shown and placed them in the Sun.

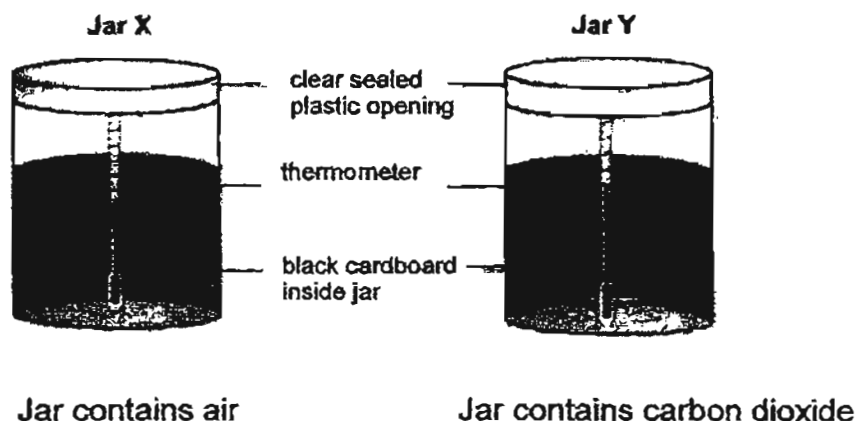

He recorded the temperature in each jar in the following table.

Time Taken (min)	Temperature (°C)	
	Jar X	Jar Y
0	29	29
5	31	34
10	33	38
15	36	43
20	40	45

What can he best infer from the above experiment?

- (1) Dark coloured environments gain heat faster than light coloured ones.
- (2) Carbon dioxide contributes greater to the greenhouse effect than air.
- (3) The jar with carbon dioxide increases in temperature faster than the jar with air.
- (4) There is no difference in heat gained or heat loss since both jars contain carbon dioxide.

22 Look at the diagrams below.



River flows to the sea  
A



Rain  
B

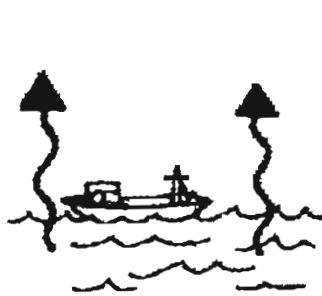

Water evaporates  
C

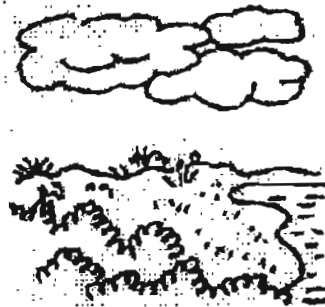

Clouds move over land  
D

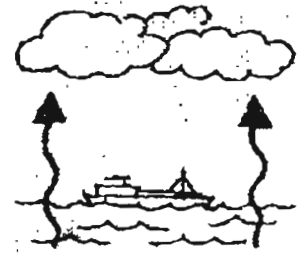

Clouds form  
E

Which of the following is the correct sequence for water cycle?

- (1) A, C, D, E, B
- (2) B, A, C, E, D
- (3) C, D, E, B, A
- (4) D, E, C, B, A...

- 24 Ahmad set up an experiment with the following apparatus and left them in a warm and windy place in the classroom.

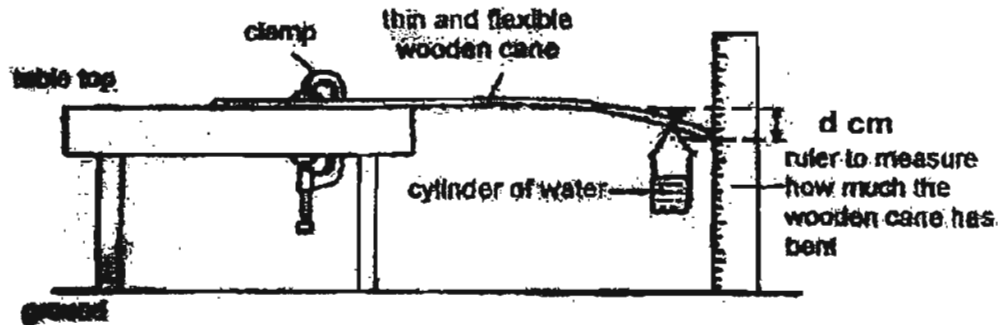

He started the experiment with 250ml of water in a measuring cylinder. He recorded the amount of water left in the cylinder as well as the difference in the height between the table top and the end of the wooden cane,  $d$  (cm), over a period of time.

Which of the following graphs shows the changes in the value of  $d$  with time?

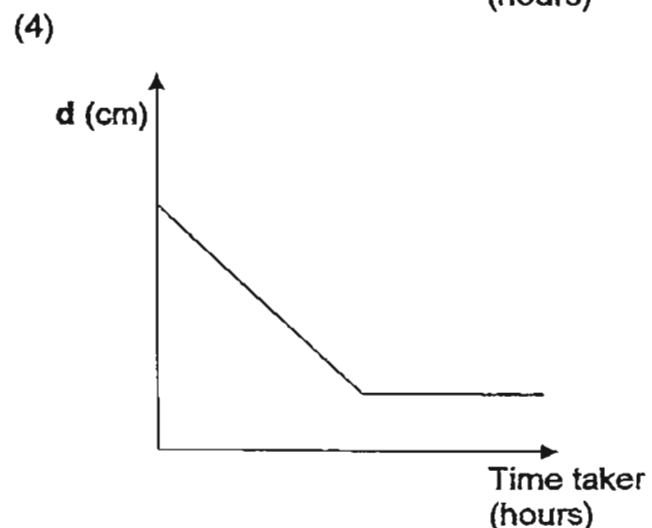
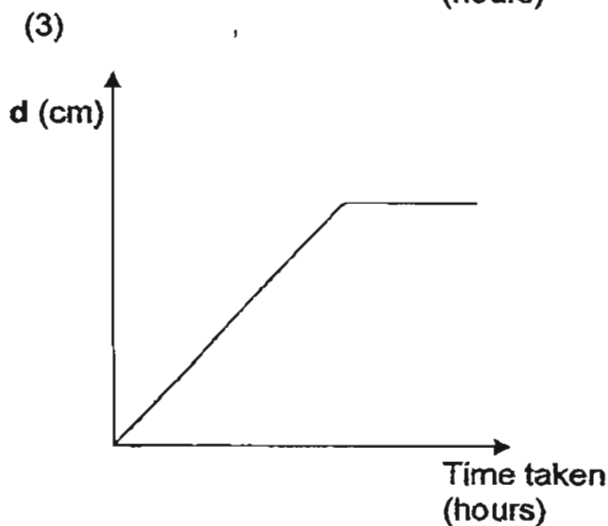
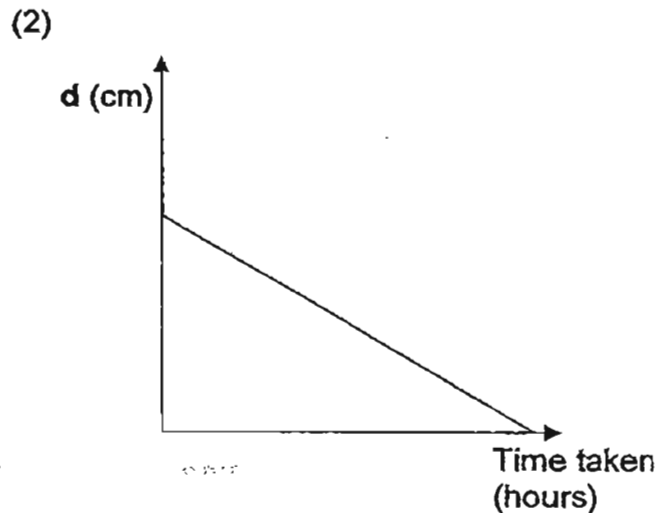
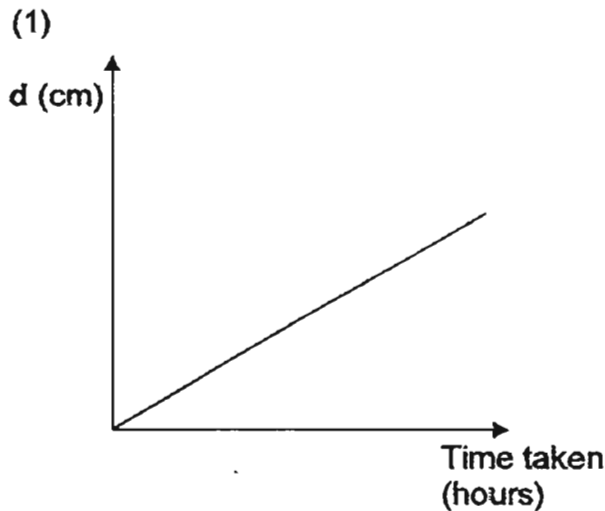



- 25 The diagram below shows the maximum weight each of the four types of string labelled P, Q, R and S can support without breaking.

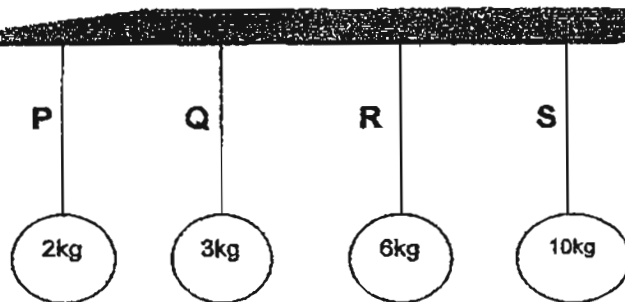

In which diagram(s) will all strings remain unbroken?

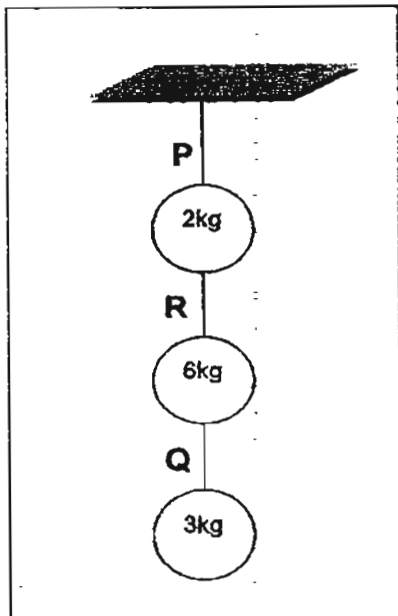

Diagram A

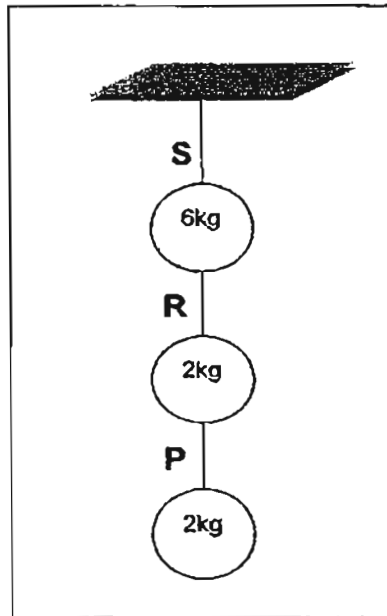

Diagram B

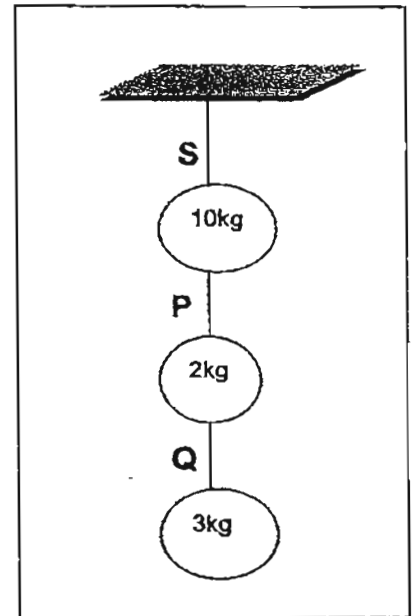
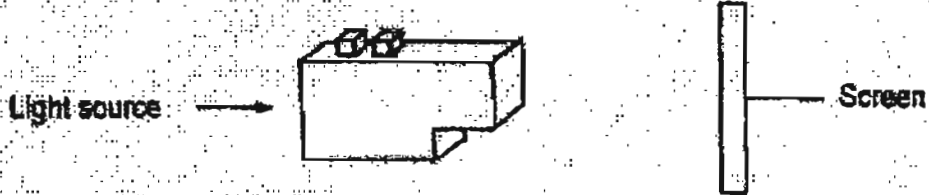

Diagram C

- (1) A only  
 (2) B only  
 (3) B and C only  
 (4) A, B and C only

- 26 A shadow was cast on the screen from a light source as shown in the following diagram.



Which of the following diagram shows the shadow that is cast on the screen?

(1)



(2)



(3)



(4)



27 Heidi wanted to find out how the arrangement of the bulbs in a circuit will affect their brightness. She set up the following circuits using identical components.

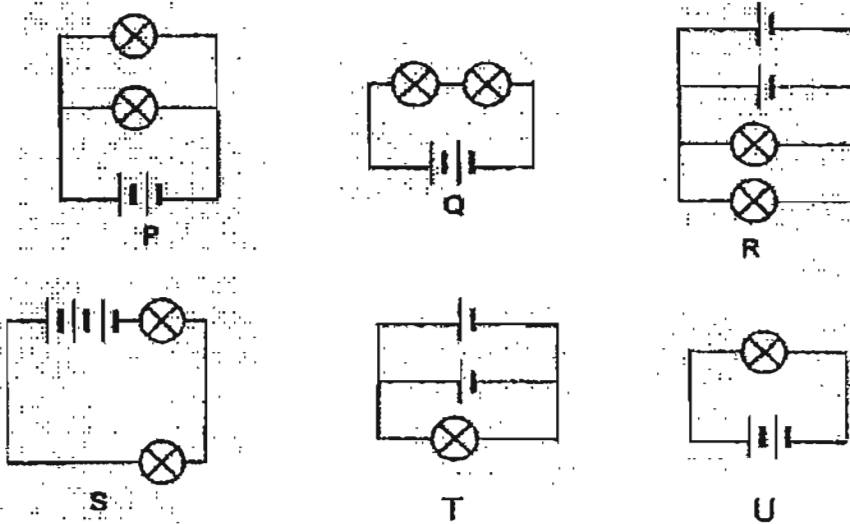

Which two of the above arrangements can Heidi use to carry out the experiment?

- |             |             |
|-------------|-------------|
| (1) T and U | (2) Q and U |
| (3) R and S | (4) P and Q |

28 Study the diagram below carefully.

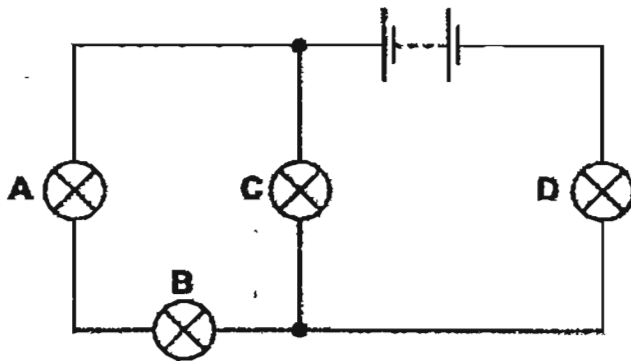

In the circuit shown above, one of the bulbs fuses, causing all the other bulbs not to light up. Which one of the bulbs has fused?

- |       |       |
|-------|-------|
| (1) A | (2) B |
| (3) C | (4) D |

29 A girl is sitting on a moving swing as shown in the figure below.

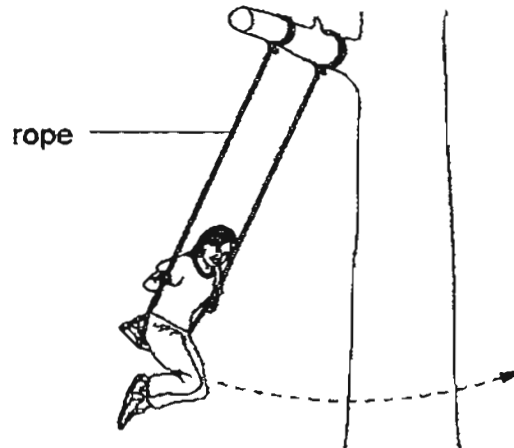

Which of the following force(s) does she have to overcome in order to swing to the other end?

- A Weight
- B Elastic force
- C Frictional force
- D Gravitational force

- (1) A and C only
- (2) B and D only
- (3) A, C and D only
- (4) B, C and D only

30 Muthu was standing 5 m away from a wall while shining a torchlight at a chair which was 2 m away from the wall as shown below.

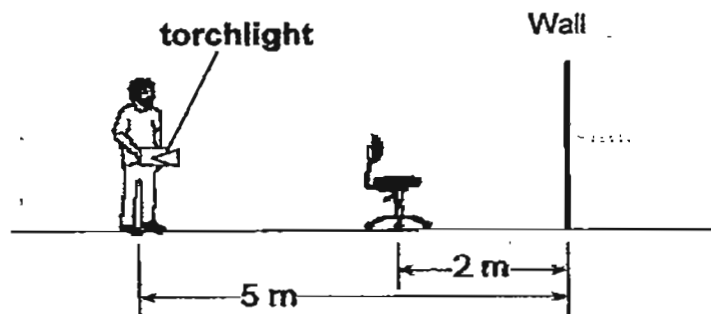

His friend came by and shifted the chair by some distance. What would be the new distance between Muthu and the chair now if he observed the shadow of the chair on the wall became bigger without moving himself away at all?

- (1) 2 m
- (2) 4m
- (3) 3 m
- (4) 5m

End of Booklet A



**Rosyth School**  
**Preliminary Examination for 2011**  
**STANDARD SCIENCE**  
**Primary 6**

Name: \_\_\_\_\_

Total  
Marks:

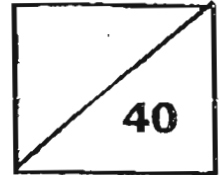

Class: Pr \_\_\_\_\_

Register No. \_\_\_\_\_

Duration: 1 h 45 min

Date: 25 August 2011

Parent's Signature: \_\_\_\_\_

---

## **Booklet B**

Instructions to Pupils:

1. For questions 31 to 44, give your answers in the spaces given in this Booklet B.

\* This booklet consists of 14 pages.

This paper is not to be reproduced in part or whole without the permission of the Principal.

**PART II ( 40 MARKS)**

**For questions 31 to 44, write your answers in this booklet.**

**31** Johnny visited the eco-garden in school and saw a plant with green leaves but without any flowers. He concluded that the plant is a non-flowering plant but his teacher did not agree.

**(a)** Give two possible reasons why the teacher said that the plant may be a flowering plant although there were no flowers when Johnny observed it. [2]

Reason 1: \_\_\_\_\_  
\_\_\_\_\_  
\_\_\_\_\_

Reason 2: \_\_\_\_\_  
\_\_\_\_\_  
\_\_\_\_\_

**(b)** State one characteristic of the kind of plants that are definitely non-flowering. [1]

\_\_\_\_\_  
\_\_\_\_\_

32 The picture below show an ant-mimic jumping spider.

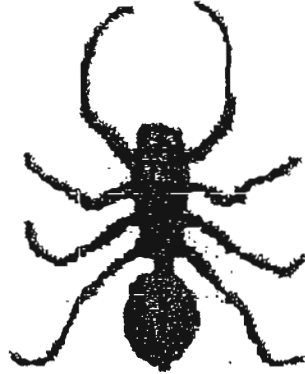

In the forest, it is often mistaken as an ant.

(a) How does looking like an ant benefit the spider? [1]

---

---

(b) How does the spider make itself appear to have only six legs? [1]

---

---

The diagram below shows a typical garden spider and an ant.



(c) How are the body parts of the spider different from the ant? [1]

---

---

33 The diagram below shows a male and female flower each taken from a separate fruit tree of the same species.



(a) Which flower is a female flower? Give a reason for your choice. [1]

---

---

(b) Explain why self-pollination cannot take place in either of these flowers. [2]

---

---

(c) Complete the drawing of a flower in the box below which enables self-pollination to take place. [1]

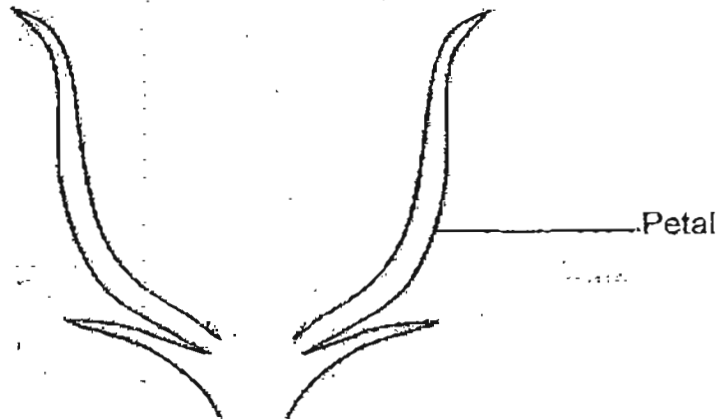



- 34 Jin Jin conducted an experiment using the 2 set-ups as shown in the diagram below. In set-up A, she placed a plant shoot with leaves and a white flower in it. In set-up B, she used a straw with holes where leaves and a white flower are attached to it instead.

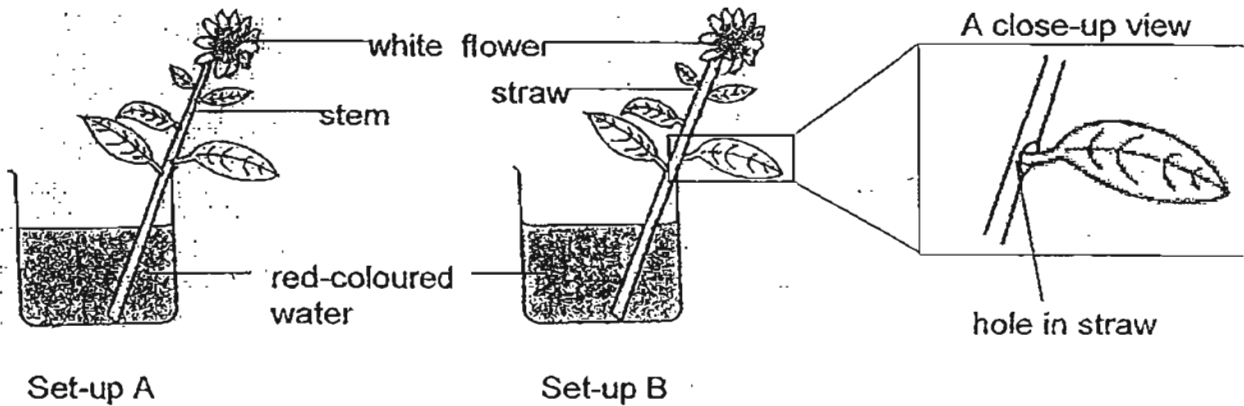

After a few hours, the white flower in set-up A turned red but the flower in set-up B did not. She cut the stem of the plant in set-up A and viewed it using a microscope.

- (a) What would she observe? [1]

---

---

- (b) What was the purpose of set-up B? [1]

---

---

---

- 35 Some students carried out an investigation to find out what happens to our pulse rate after exercise. They got Peter to perform a vigorous exercise for 10 minutes. The graph below shows his pulse rate after exercise.

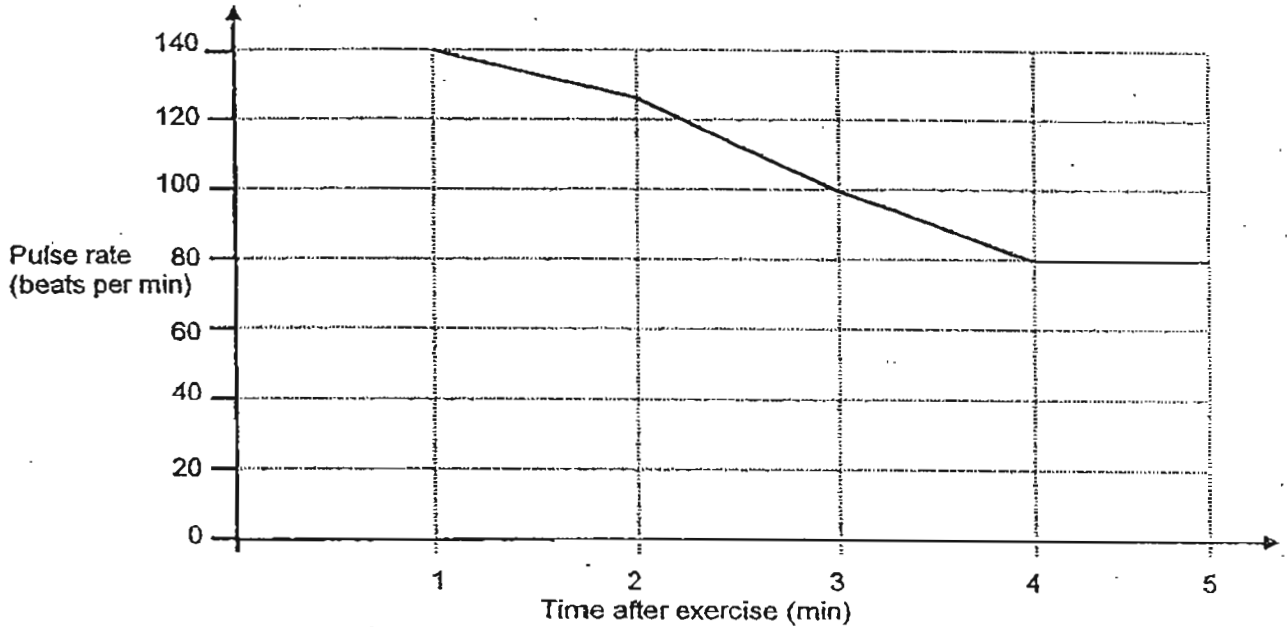

- (a) From the graph, state Peter's normal pulse rate.

[1]

- (b) On the axes below, draw a graph to show the breathing rate of Peter after vigorous exercise in the same investigation.

[1]

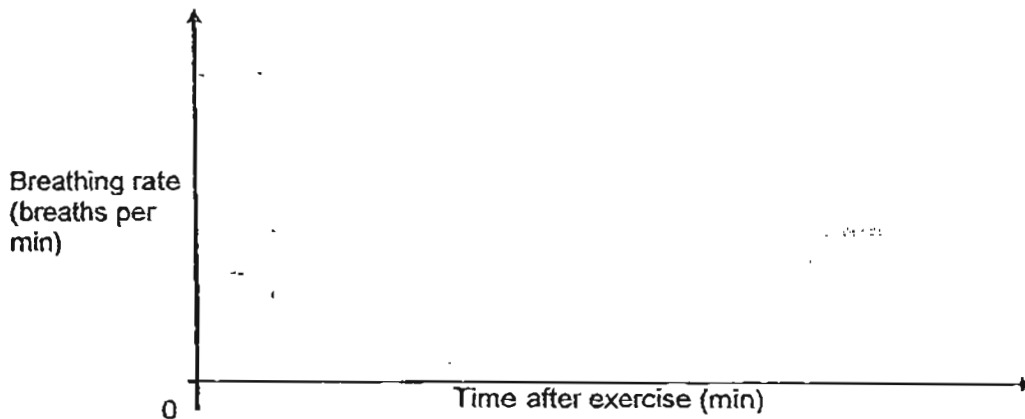

- (c) How do our respiratory and circulatory systems work together to supply oxygen to our body parts?

[1]

---



---



---

36 The river shown in the diagram below is polluted by untreated human waste.

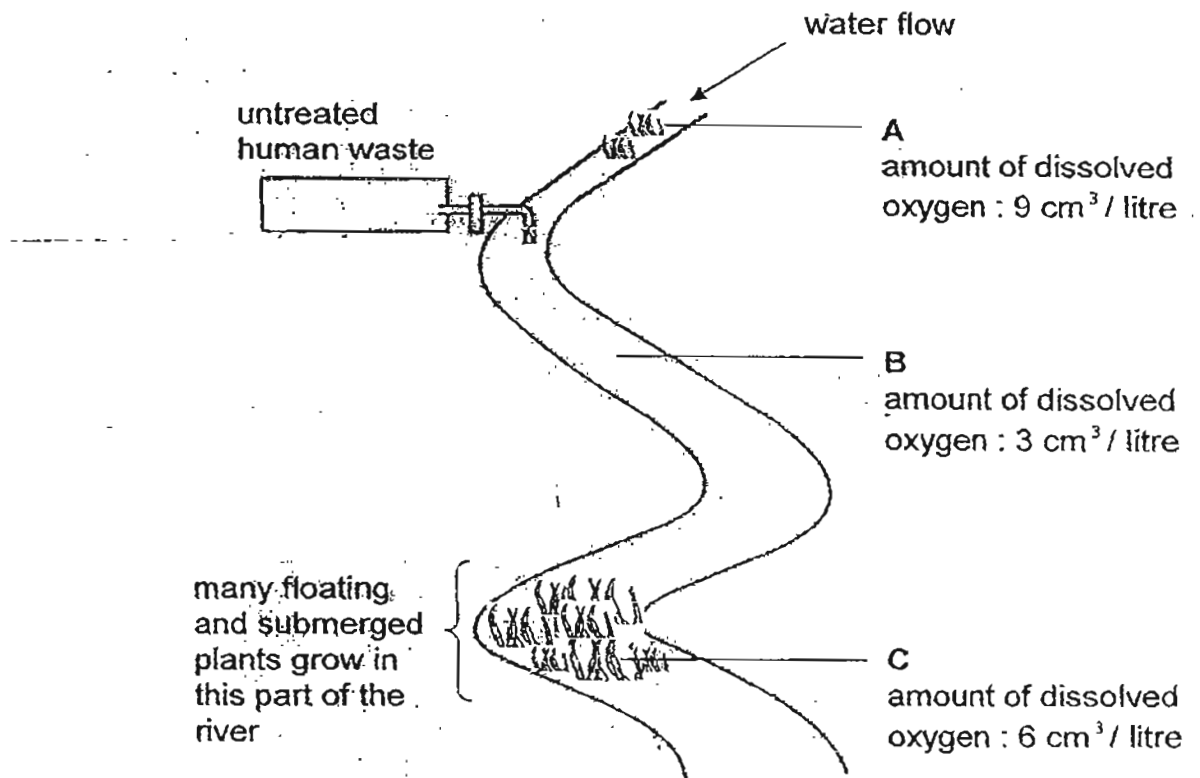

(a) In which part of the river, A or B, is the number of bacteria greater? Explain your answer. [1]

---



---



---

(b) Explain why more plants grow at C than at A. [1]

---



---

(c) In which part of the river, A, B or C, will there be the most fish? Explain your answer. [1]

---



---



---

37 Rani set up a bottle garden as shown in the diagram below. In it she placed some small animals and plants.

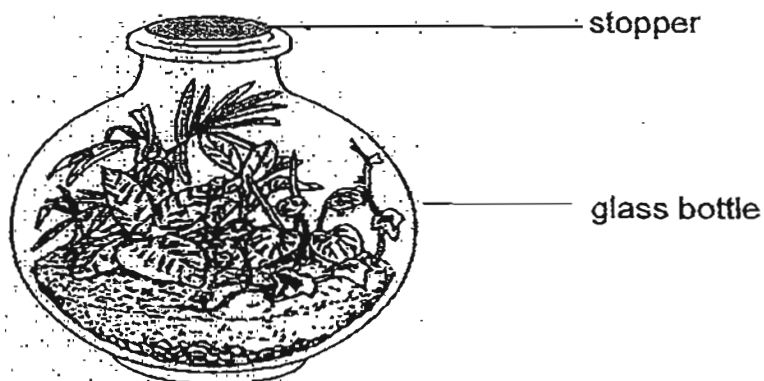

She sealed her bottle garden tightly with a stopper after watering the plants. She left the bottle garden near a window and did not water the garden for two weeks.

Explain how the sun is useful to the bottle garden in two ways.

[2]

---

---

---

---

---

- 38 When a ball is being thrown in the air, the ball can possess potential energy (PE), kinetic energy (KE) or a combination of both types of energy (PE + KE).

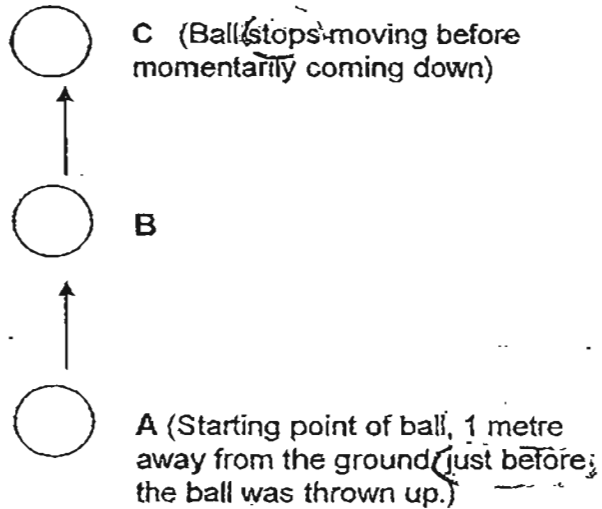

- (a) Identify the type(s) of energy the ball possesses at stages ~~A and B~~ <sup>A, B and C</sup>, as the ball moves up into the air before coming down by putting a tick in the correct boxes as follows. [1]

Stage	Type of Energy		
	PE	KE	PE+KE
A			
B			
C			

- (b) Name the force(s) the ball is subjected to throughout the whole pathway of the throw. [1]

- 39 Simon carried out the following experiment with the set-up as shown.

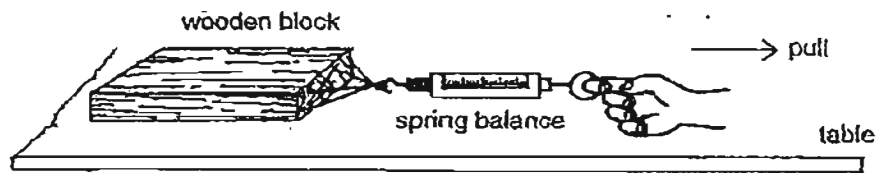

- (a) What kind of energy does the hand possess in pulling the spring balance? [1]

---

- (b) Simon found it rather difficult to pull the wooden block across the table. Explain what he can do to move the wooden block across the table more easily. [1]

---



---

- 40 Alex had two different liquids A and B of the same volume each in separate jar. He placed two solids P and Q into the liquid and noted that the position at which P and Q come to rest.

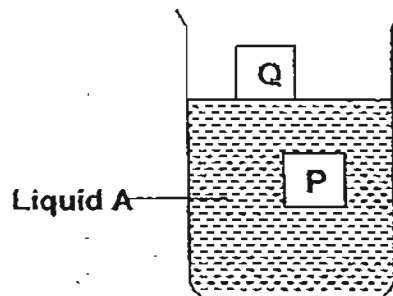

Next he removed the solids from liquid A and placed them in liquid B. Again he noted their positions.

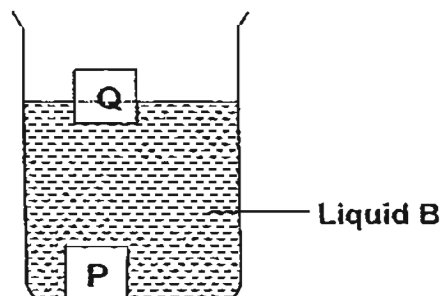

Question 40 is continued on page 10.

- (a) Study the results of Alex's experiment and complete the classification table with the correct letters A, B, P and Q. [2]

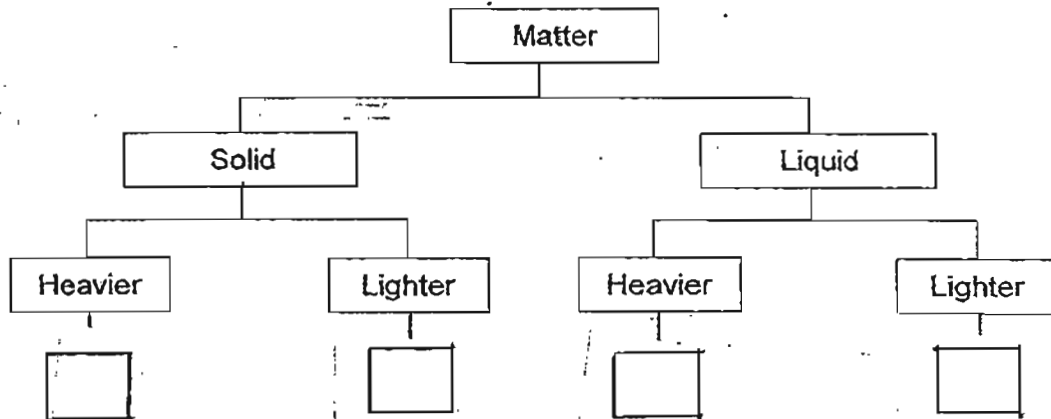

- (b) After the experiment, Alex removed solids P and Q from liquids A and B and heated both liquids separately at 25°C with the same intensity of heat until they reached boiling points. Alex observed that in liquid A, 'clouds' were seen on top of the jar earlier than liquid B.

Using the information given, sketch the graphs of the process of heating liquids A and B on the axes below. Label your drawing. [2]

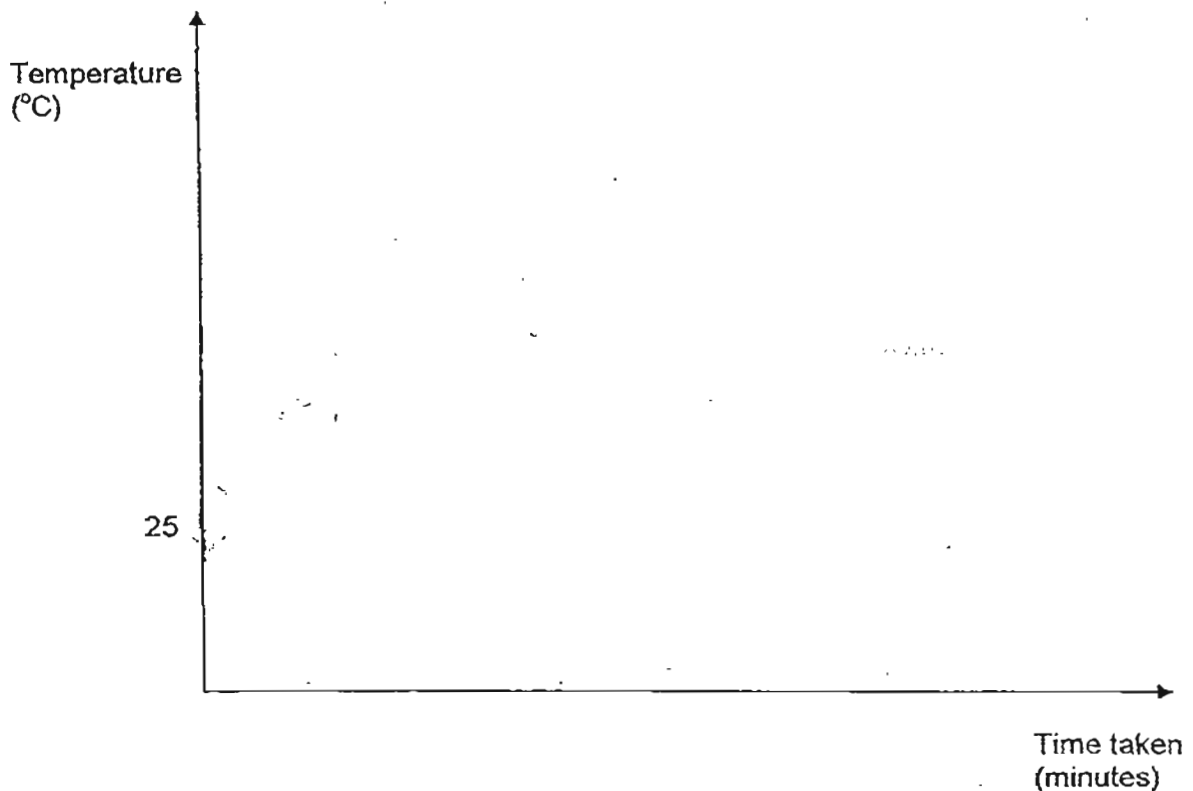

41 Jenny is trying to make a toy house for her doll and she wants to fix 2 bulbs in the living room and another 1 bulb in the bedroom with only the following items.

- Three dry cells
- Three bulbs
- Some wires
- One switch

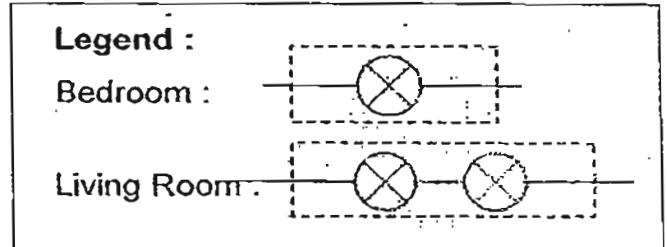

In her first attempt, the amount of light in each room is of equal brightness.

In her second attempt, the amount of light in one room is brighter than the other.

Draw the two circuit diagrams that Jenny has attempted in the space given below. Use dotted lines to indicate the different rooms and label them. [2]

**Arrangement 1 (First attempt)**

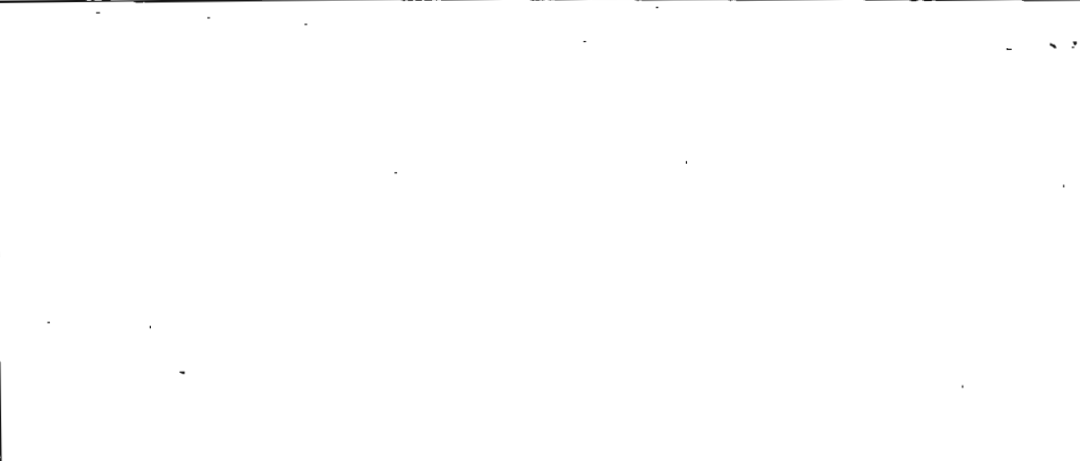

**Arrangement 2 (Second attempt)**

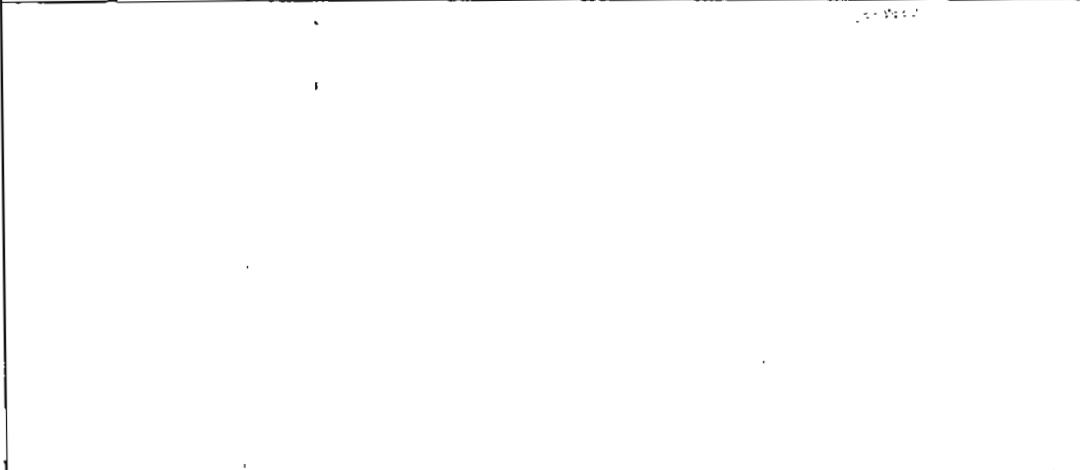



- 42 Sze Hua collected 3 samples of water from 3 different ponds X, Y and Z at various sites. Using the set-up below, she placed each sample of water in front of the light and heat sensor of the datalogger and recorded the amount of light that passed through the samples of water collected in the beaker and the temperature of the water.

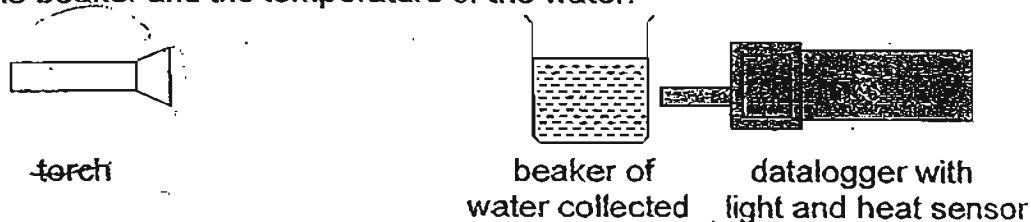

Sample of water from pond	Amount of light received by the sensor /lux	Temperature of pond water at site / °C
X	1	40
Y	143	30
Z	266	20

- (a) List 2 variables that must be kept constant to ensure a fair test. [1]

- i. \_\_\_\_\_
- ii. \_\_\_\_\_

- (b) If a coin is dropped into the three beakers containing samples of water from pond X, Y and Z respectively, in which beaker will the coin be most visible? Explain your answer. [1]

\_\_\_\_\_

\_\_\_\_\_

\_\_\_\_\_

- (c) State the relationship between the clarity of the water and the temperature of the water. [1]

\_\_\_\_\_

\_\_\_\_\_

- (d) Pond X was found to have the least amount of aquatic animals living in it. Suggest a reason why this is so. (Do not mention about the temperature or the clarity of water.) [1]

\_\_\_\_\_

\_\_\_\_\_

- 43 The diagram below shows a magnet placed 30cm away from a magnetic material.

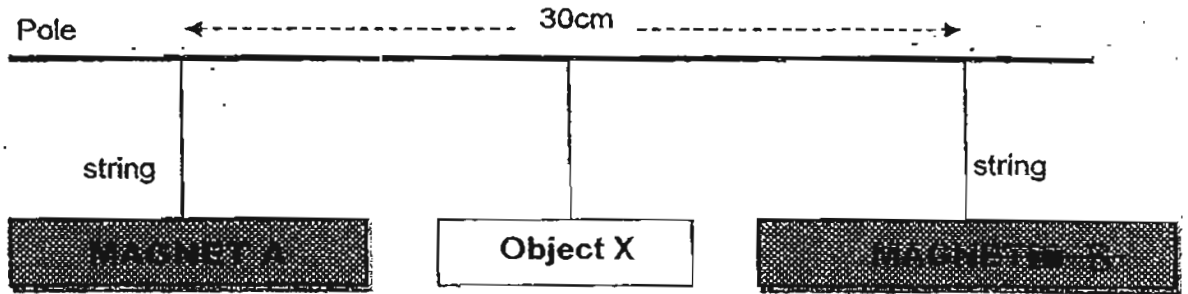

- (a) If object X is a magnet hung in between A and B, what would happen to A and B? Draw in the box given below to show one possible result. (Label all the poles in your drawing.) [1]

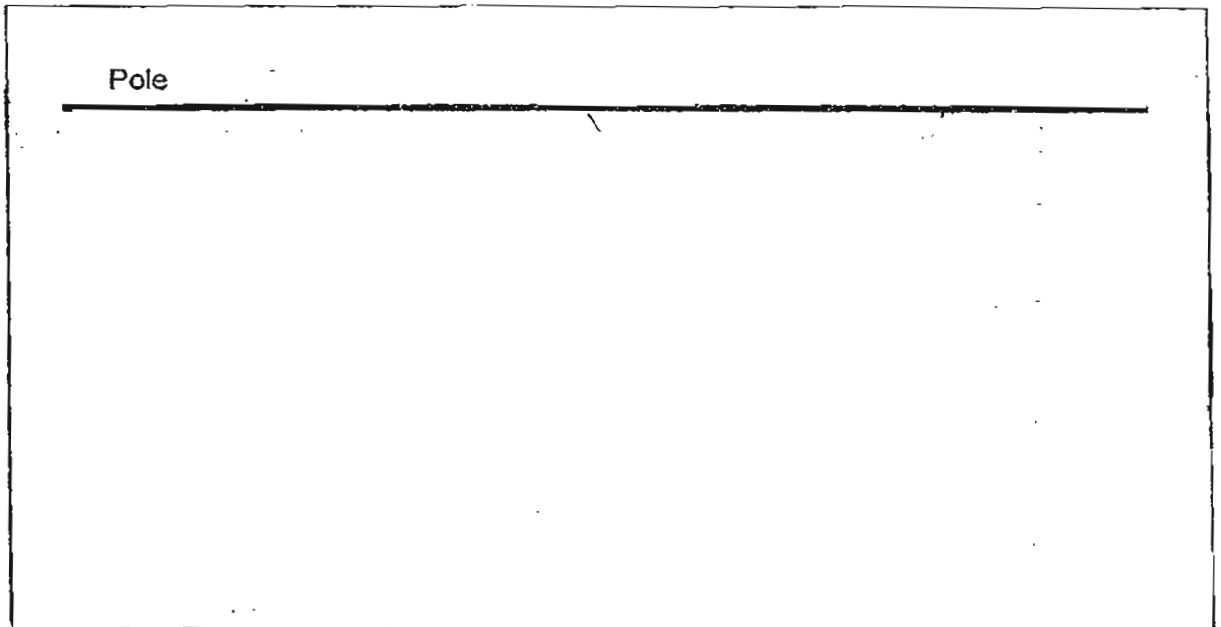

- (b) State the property that has caused the above result. [1]

# Answer Ke

## EXAM PAPER 2011

SCHOOL : ROSYTH  
SUBJECT : PRIMARY 6 SCIENCE

TERM : PRELIMINARY

Q1	Q2	Q3	Q4	Q5	Q6	Q7	Q8	Q9	Q10	Q11	Q12	Q13	Q14	Q15	Q16	Q17
2	3	4	1	4	2	4	2	2	3	1	1	3	2	1	2	4

Q18	Q19	Q20	Q21	Q22	Q23	Q24	Q25	Q26	Q27	Q28	Q29	Q30
1	4	3	1	2	2	4	2	1	4	4	3	1

31)a)1)The environmental conditions in which the plant was growing were not suitable for it to flower.

2)The flowers of the plant may not have grown yet. It may not be the correct time of the year/season for the flowers to bloom.

b)Non-flowering plants reproduce by spores. They do not have true leaves and stems.

32)a)It can prey on the ants without being noticed./It can be near to the ants to prey on them.

b)The two front legs appear to be feelers.

c)The ant has feelers while the spider does not.

33)a)Flower A is a female flower. Flower A has a stigma and an ovary.

b)The tree bears only male flowers or only female flowers, so pollen from one flower of the tree cannot pollinate it self/another flower of the same tree.

c)

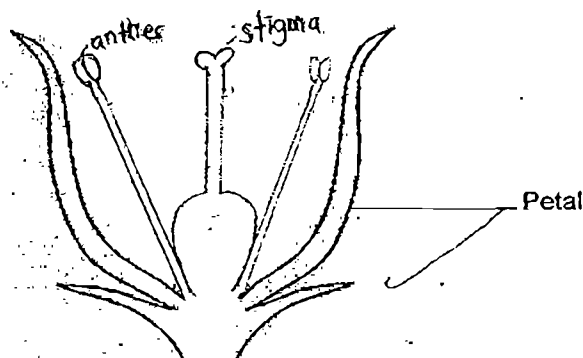

34)a)She would observe that the xylem have turned red.

b)Set-up B was a control to prove that the xylem tubes of the stem transport water to all parts of the plant.

35)a)80 beats per minute.

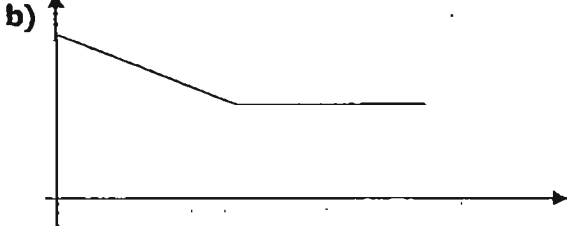

c)After respiration and gaseous in the respiratory system, the oxygen dissolves into the blood and is carried by the blood in the blood stream to different parts of our body.

36)a)There is less oxygen at B as oxygen is used up by the greater number of bacteria./There will be the more untreated waste which will cause the bacteria to multiply more.

b)Bacteria has decomposed/ broken down the waste into nutrients/fertiliser for the plants.

c)A. There is most oxygen for fish to take in.

37)1)The sun allows the plants to make food, providing food for the animals.

2)The heat increases the rate of transpiration and the water vapour condense on the sides of the jar to become water droplets.

38)a)A=PE B=PE+KE C+PE

b)Gravitational force and air resistance.

39)a)Chemical potential energy.

b)He can used lubricants such as oil to smoothen the surface of the table and reduce the amount of friction between the surface of the table and the wooden block.

40)a)P Q A B

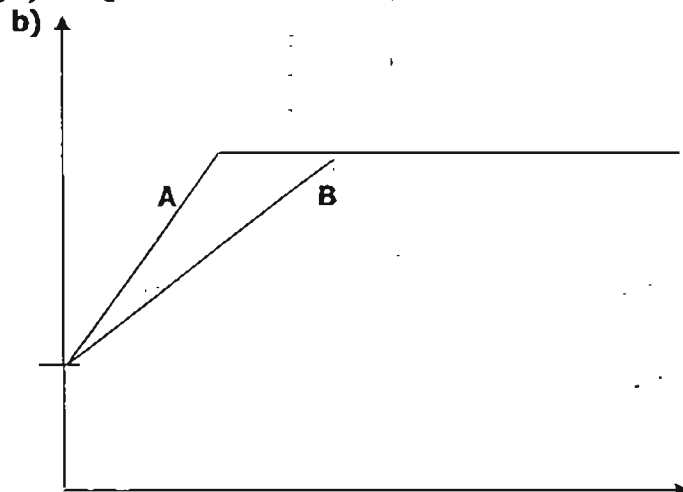

41)1)

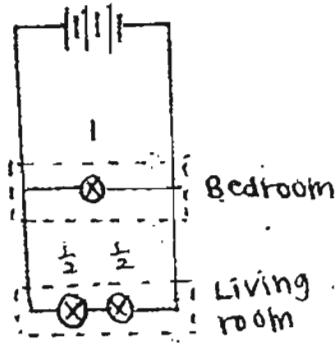

2)

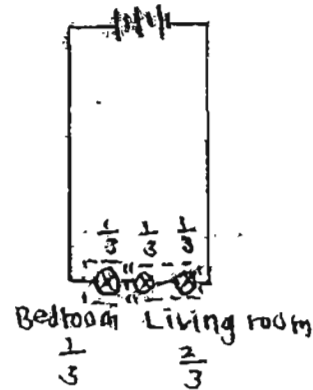

42)a)i) Amount of water/ Light intensity. The same torch/presence of other light source.

ii) Position of the torch.

b) The coin will be most visible in the beaker with the water sample from pond Z. The amount of light received by the light sensor is the greatest, which indicates that the water from pond Z is the clearest.

c) The greater the clarity of the water, the lower the temperature of the water.

d) The amount of dissolved oxygen is the least.

43)a) Pole

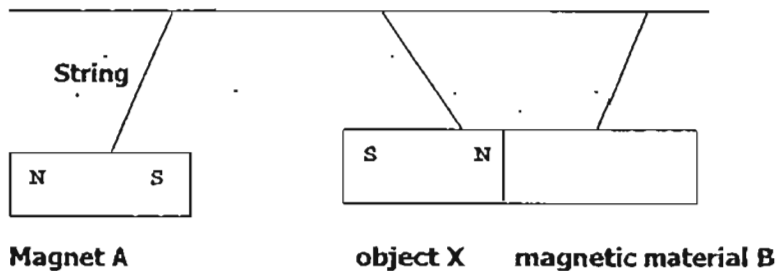

b) Like poles of magnets repel.

44)a) Evaporation, condensation, boiling and melting.

b) The snow that has been melted reached its boiling point to become steam.

c) The impurities in the snow which could not be evaporated will be left in the flask.