

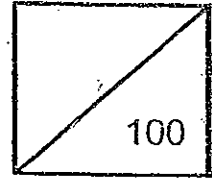

Rosyth School
Semestral Assessment 2 for 2010
SCIENCE
Primary 5



Name: _____

Total
Marks:

Class: Pr _____

Register No. _____

Duration: 1 h 45 min

Date: 28 October 2010

Parent's Signature: _____

BOOKLET A

Instructions to Pupils:

1. Do not open the booklets until you are told to do so.
2. Follow all instructions carefully.
3. This paper consists of 2 booklets, Booklet A and Booklet B.
4. For questions 1 to 30 in Booklet A, shade the correct ovals on the Optical Answer Sheet (OAS) provided using a 2B pencil.

	Maximum	Marks Obtained
Part I	60 marks	
Part II	40 marks	
Total	100 marks	

* This booklet consists of 19 pages.

This paper is not to be reproduced in part or whole without the permission of the Principal.

Part I (60 marks)

For each question from 1 to 30, four options are given. One of them is the correct answer. Make your choice (1, 2, 3 or 4). Shade the correct oval (1, 2, 3 and 4) on the Optical Answer Sheet.

1. Study the flowchart below.

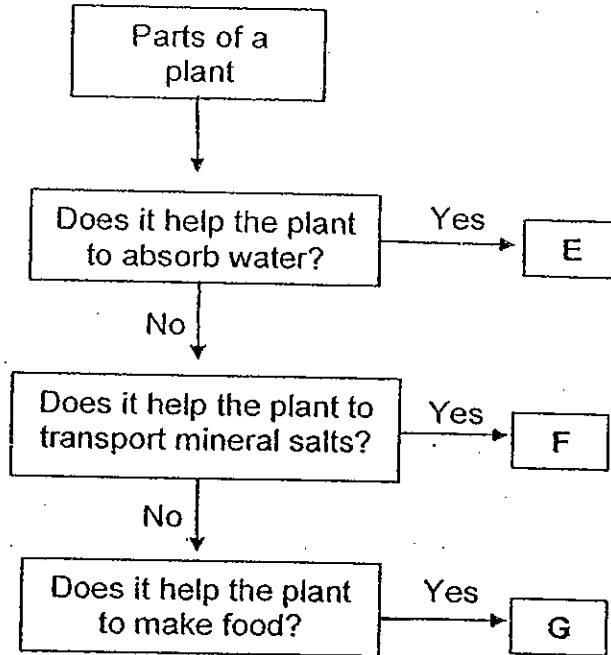

Which of the following correctly identifies E, F and G?

	E	F	G
(1)	Roots	Water-carrying tubes	Leaves
(2)	Water-carrying tubes	Food-carrying tubes	Leaves
(3)	Roots	Leaves	Food-carrying tubes
(4)	Food-carrying tubes	Water-carrying tubes	Leaves

2. Andrew observed a leaf under a microscope and saw many small openings on the underside of the leaf as shown below.

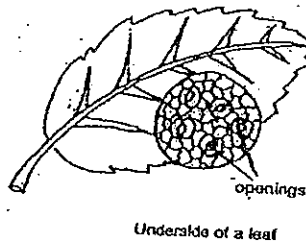

Which of the following statement(s) is/are true about the openings?

- A: They trap sunlight for the plant to make food.
- B: Water vapour can leave the plant through the openings.
- C: There are more openings on top of the leaf than the bottom of the leaf.
- D: They allow the exchange of air to take place between the plant and the surroundings.

(1) D only

(2) B and D only

(3) A, B and D only

(4) B, C and D only

3. Mei Yin carried out an investigation as shown below.

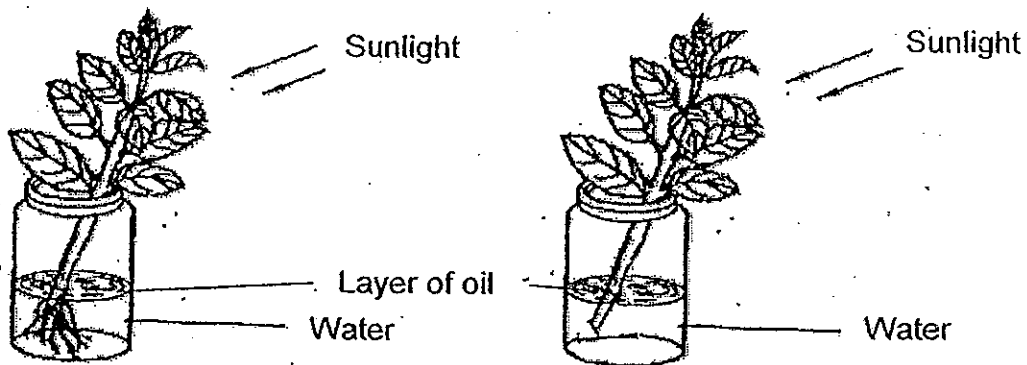

What could be the aim of her investigation?

- (1) To find out if plants need roots to take in water.
- (2) To find out if oil will affect the growth of the plant.
- (3) To find out if plants can stay upright without roots.
- (4) To find out if roots will affect the rate of photosynthesis.

4. The walls of the gullet, stomach, small intestine and large intestine are muscular. Which of the following statements describe(s) the functions of these muscles?

- A The muscles help to move food along the digestive system
- B The muscles help to mix the digestive juices and food.
- C The muscles break the food down into simpler substances.

(1) A only

(2) A and B only

(3) B and C only

(4) A, B and C

5. Edwin wanted to find out if living things give out carbon dioxide. He set up an experiment as shown below to detect the amount of carbon dioxide in the air.

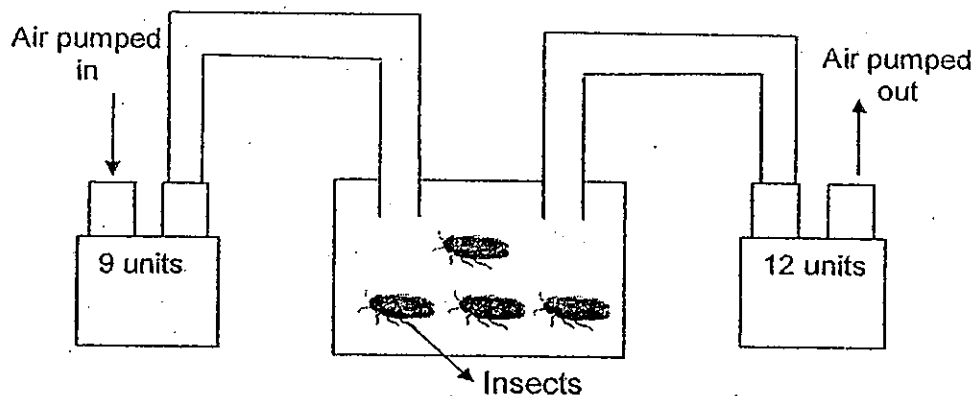

Based on the set-up and the data collected, what can he infer from the experiment?

- A: Living things take in oxygen.
- B: Living things give out carbon dioxide.
- C: The more insects there are, the more amount of carbon dioxide is given out.

(1) B only

(2) A and B only

(3) B and C only

(4) A, B and C

6. Which of the following body systems help(s) in the release of energy a body needs to carry out daily activities?

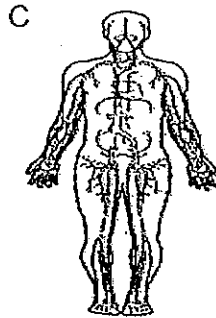
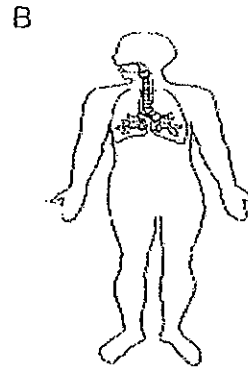
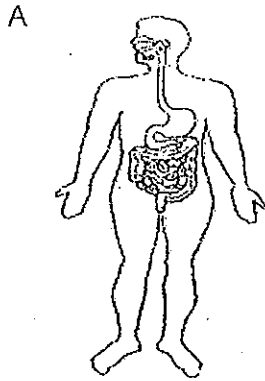

~~(1)~~ A only

~~(3)~~ A and C only

~~(2)~~ C only

~~(4)~~ A, B and C

7. Study the graph below.

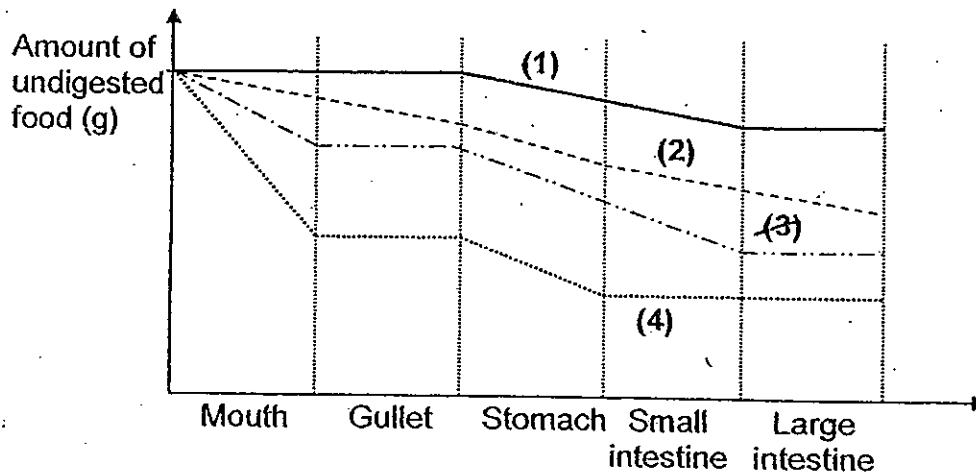

Which line correctly shows the amount of undigested food in the human digestive system?

8. Ganesh set up an experiment as shown below.

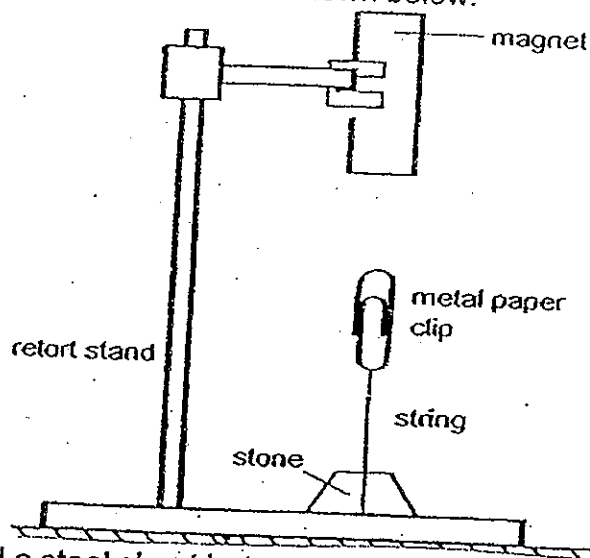

He then placed a steel sheet between the magnet and the metal paper clip as shown below.

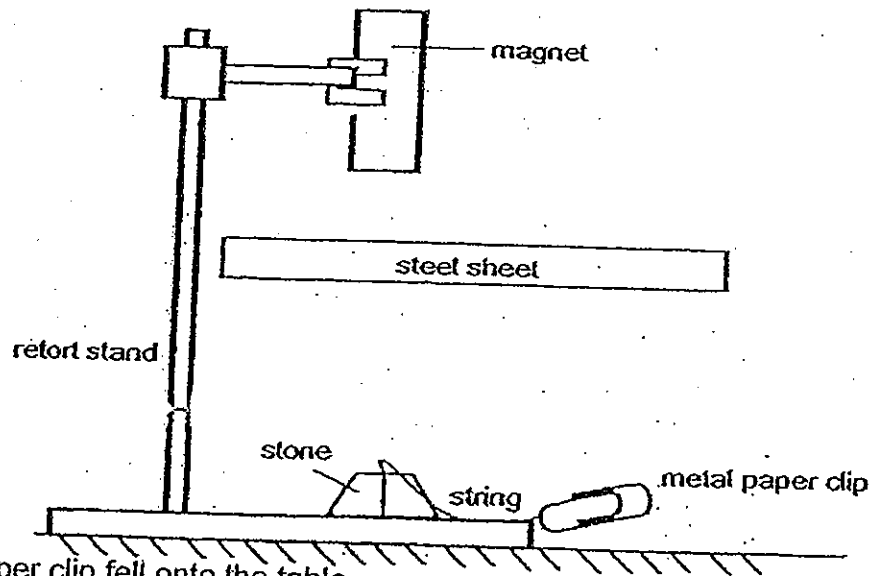

The metal paper clip fell onto the table.
What can he infer from his experiment?

- (1) The magnet lost its magnetism.
- (2) The steel sheet became a permanent magnet.
- (3) The magnetic force cannot go through the steel sheet.
- (4) The steel sheet caused the repulsion between the steel sheet and the paper clip.

9. The following diagrams show different types of cells.

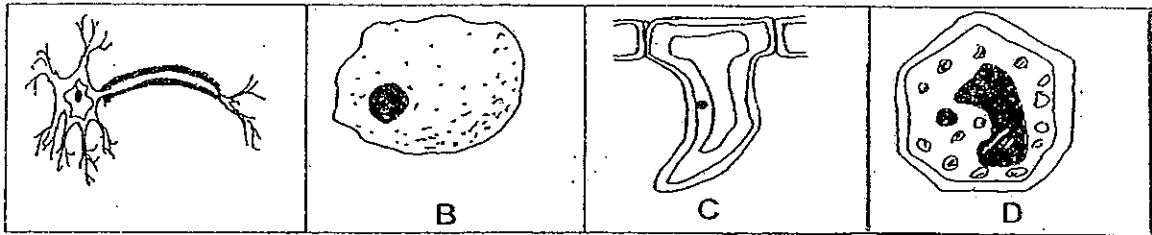

Which one of the following shows the correct grouping of the cells?

	Animal Cell	Plant Cell
(1)	A, B	C, D
(2)	A, C	B, D
(3)	B, C	A, D
(4)	C, D	A, B

10. The picture below shows a plant cell.

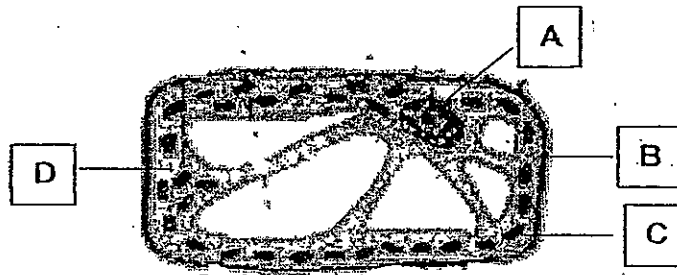





Which part of the cell allows most activities to take place in it?

(1) A
(3) C

(2) B
(4) D

11. Which one of the electrical components does not match the circuit symbol?

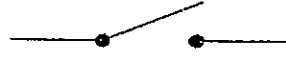
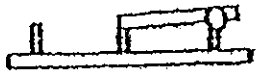
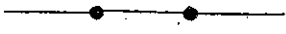
	Electrical Component	Circuit Symbol
(1)		+ -
(2)		
(3)		
(4)		

12. A circuit diagram is set up as shown below. Bulb A and B will light up in equal brightness when the switch is closed.

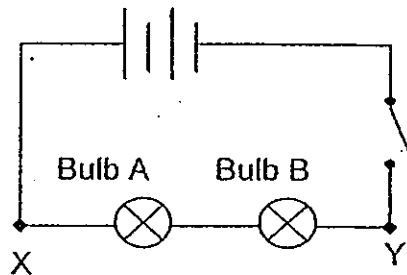

Bulb C is then connected to the circuit at X and Y.

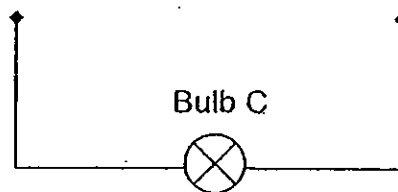

What will happen to Bulb A?

- (1) It will become brighter than before.
- (2) It will become dimmer than before.
- (3) It will light up with the same brightness.
- (4) The bulb will fuse and it will not light up.

13. Samuel wanted to find out if the arrangement of bulbs will affect the length of time a bulb is lit. He then set up four circuits as shown below.

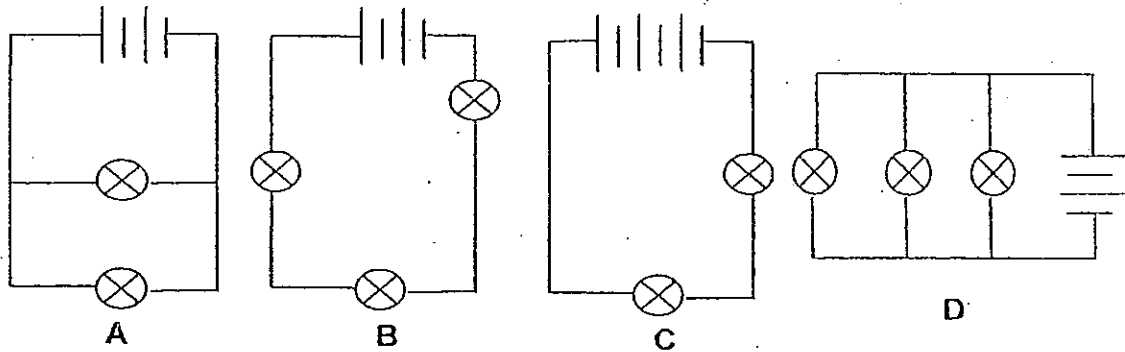

Which two circuits should he use to ensure a fair test?

- (1) A and C (2) A and D
 (3) B and D (4) C and D

14. Zhi Yu conducted an experiment using one of the four circuits as shown below. He then recorded his results in a table as shown below.

Switch A	Switch B	Number of bulbs lit
Open	Open	0
Close	Open	1
Open	Close	2
Close	Close	2

Which one of the following circuits did Zhi Yu use?

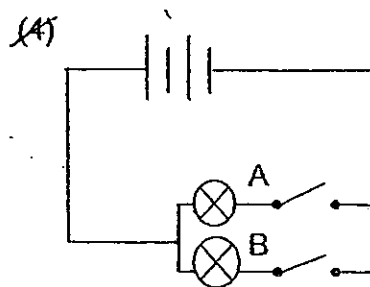
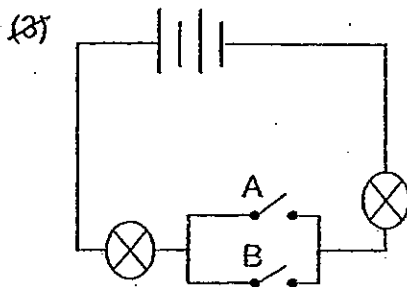
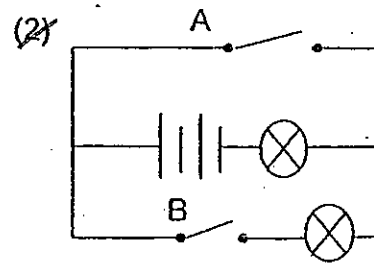
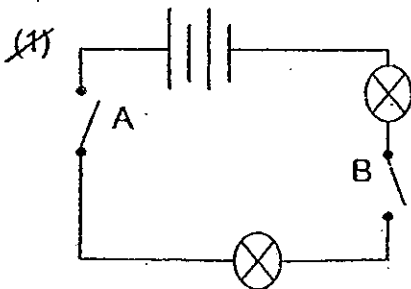

15. Elena is given 4 bars of different materials. Two bars are conductors of electricity and other two are non-conductors of electricity. She needs to place the four bars, A, B, C and D at different points of the circuit as shown below.

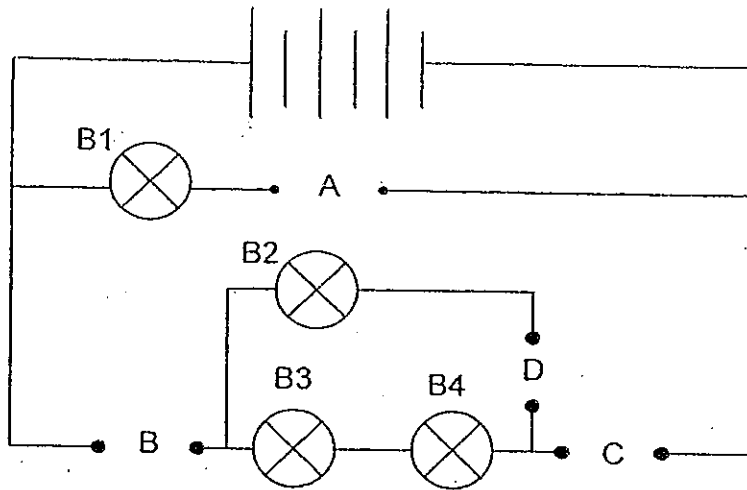

Where should Elena place the two bars of non-conductors of electricity so that only two bulbs will light up?

- ~~(1)~~ A and C
~~(3)~~ B and C

- ~~(2)~~ A and D
~~(4)~~ B and D

16. The diagram below shows a food web made up of 8 organisms, A, B, C, D, E, F, G and H.

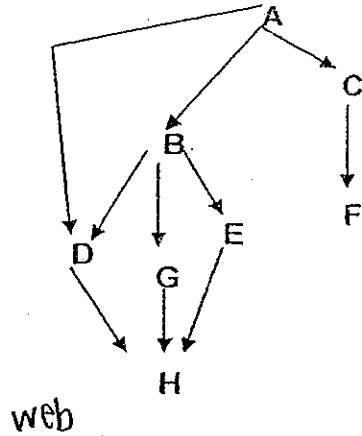

Using the food chain above, which one of the following food chains formed is correct?

- ~~(1)~~ C → F
- ~~(2)~~ A → D → G
- ~~(3)~~ B → G → E
- ~~(4)~~ A → B → E → H

17. Zena caught three different types of animals, A, B and C from a pond. She placed them into two aquariums, 1 and 2. She put animals A and B into aquarium 1 and animals A and C into aquarium 2. She also put some plants in both aquariums and supplied them with air using an air pump.

Zena counted the number of animals in both aquariums every week and she did this for a month. She plotted her findings in the graphs shown below. There were no dead organisms found in both aquariums.

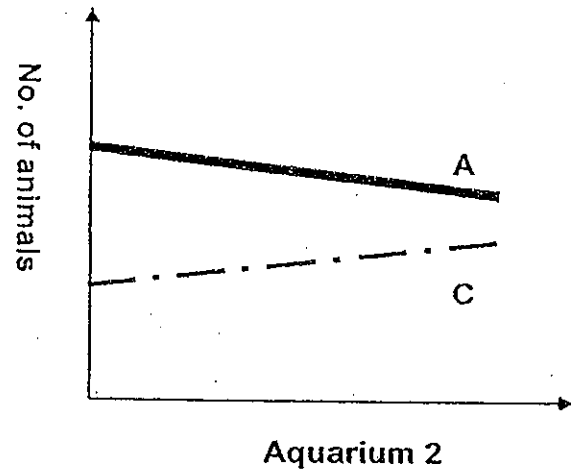
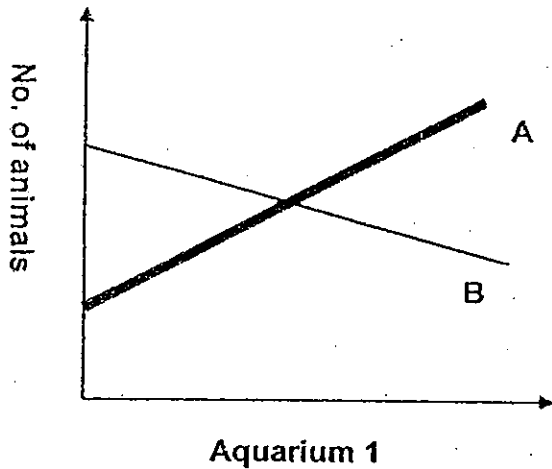

From the graphs above, which one of the following correctly shows the relationship between animals A, B and C?

- (1) $A \rightarrow B \rightarrow C$
 (2) $C \rightarrow A \rightarrow B$
 (3) $B \rightarrow A \rightarrow C$
 (4) $C \rightarrow B \rightarrow A$

18. Study the food relationship between organisms shown in the diagram below.

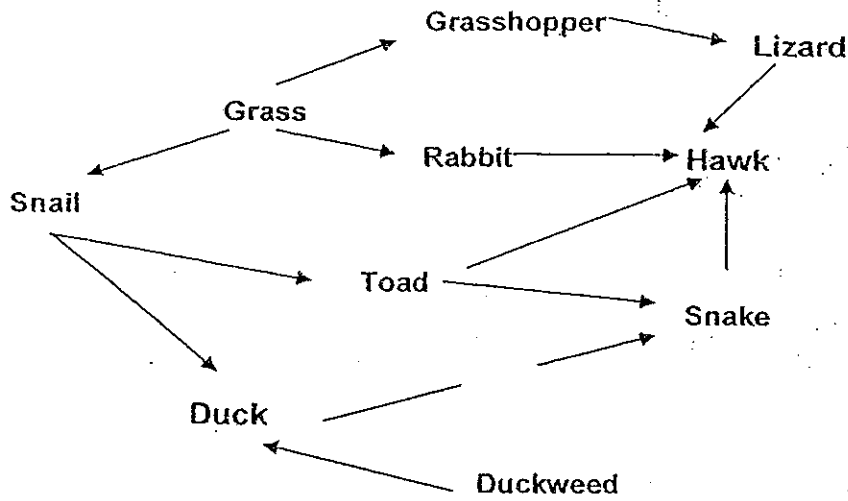

Which of the following statements about the above diagram is true?

- A: There are only 6 food chains in the diagram above.
- B: The organisms in the food web are interdependent.
- C: There are only 2 organisms which play the role of prey and predator.

- ~~(1)~~ A only
- ~~(2)~~ B and C only
- ~~(3)~~ C only
- (2) A and C only
- (4) A and B only

19. Look at the pictures of the 4 different types of feet below. Which type of feet is the most suitable for catching and grasping prey?

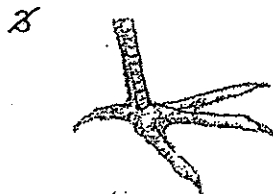

20. Mandy found out that a camel has large feet to prevent it from sinking into the sand in the desert. He conducted an investigation using wooden blocks, A, B, C and D of 4 different sizes. He placed the wooden blocks in a tray of plasticine. He placed identical weights on the wooden blocks as shown below.

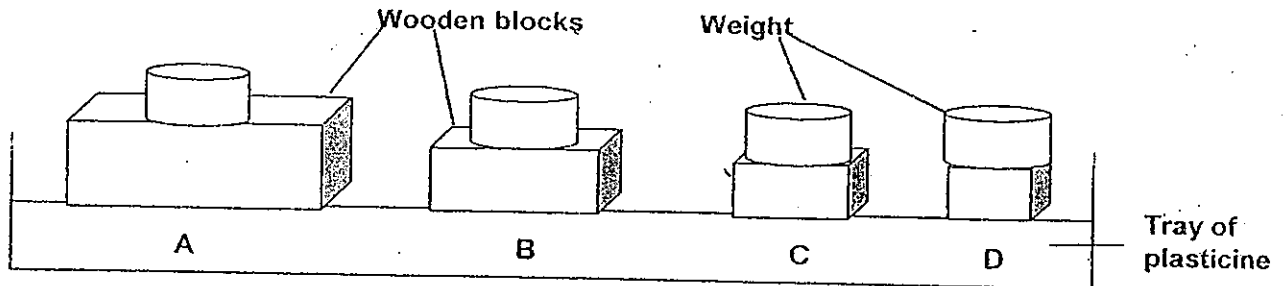

He removed the wooden blocks from the tray and measured the dent created as shown below.

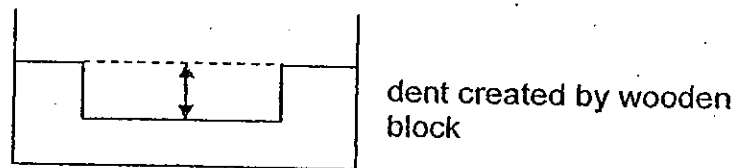

Which one of the wooden blocks would have created the greatest impact in the tray of plasticine?

(1) A
(3) C

(2) B
(4) D

21. Fish have structural adaptations which help them to move in the water. Which of the following are structural adaptations that will help a fish to move in water?

- ~~A:~~ Their tail fins enable them to propel forward in water.
- ~~B:~~ They move close to the water surface to take in oxygen.
- ~~C:~~ Their gills help them to take in dissolved oxygen in the water.
- ~~D:~~ They have streamlined bodies to overcome water resistance

(1) A and B only
(2) C and D only

(2) A and D only
(4) A, B, C and D

22. The table below shows organisms living in different habitats.

Organism	Number	Habitat
A	10	Pond
B	30	Field
Young of A	40	Pond
C	20	Pond
D	15	Field
Young of B	30	Field

How many populations are living in the pond?

~~(1)~~ 6
~~(3)~~ 3

~~(2)~~ 2
~~(4)~~ 4

23. Kate observed two types of habitats P and Q and made some notes about them in the table below.

Observation	Habitat P	Habitat Q
There was maximum sunlight.		✓
Grasshoppers were hopping around.		✓
Many earthworms and millipedes were living here.	✓	
Dark and damp conditions throughout the day.	✓	

Which one of the following best identifies habitats P and Q?

	Habitat P	Habitat Q
(1)	Garden	Swamp
(2)	Rotting log	Seaside
(3)	Field	Pond
(4)	Rotting log	Field

24. A group of students collected rubbish during a beachcombing activity. They sorted the rubbish into two separate trash bags, X and Y, containing items that could decompose and items that could not decompose respectively.

Which one of the following show what the two trash bags would contain?

	Bag X	Bag Y
(1)	Glass bottles Rubber boots Empty aluminum cans	Plastic boots Dead plants Cardboard boxes
(2)	Dead plants Cardboard boxes	Glass bottles Plastic boots Empty aluminum cans
(3)	Dead plants Empty aluminum cans	Glass bottles Plastic boots Cardboard boxes
(4)	Rubber boots Empty aluminum cans	Dead plants Glass bottles Cardboard boxes

25. Look at the concept map below.

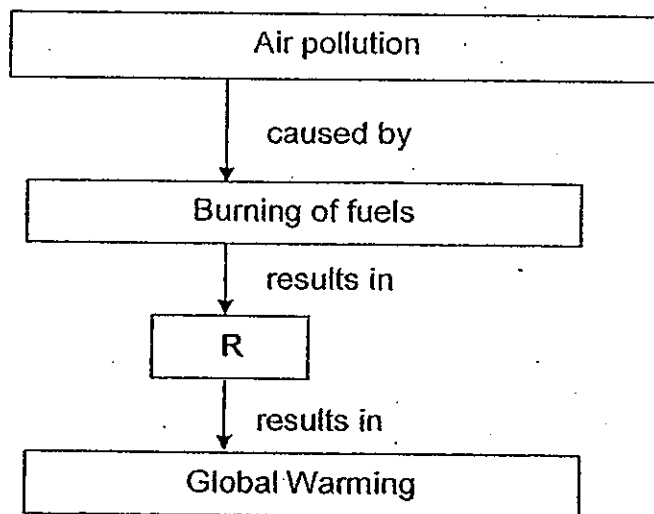

What is R likely to be?

- ~~(1)~~ Deforestation
- ~~(2)~~ Formation of acid rain
- ~~(3)~~ Depletion of ozone layer
- ~~(4)~~ Increased Greenhouse effect

26. Sherry arranged 3 magnets as shown in the picture below.

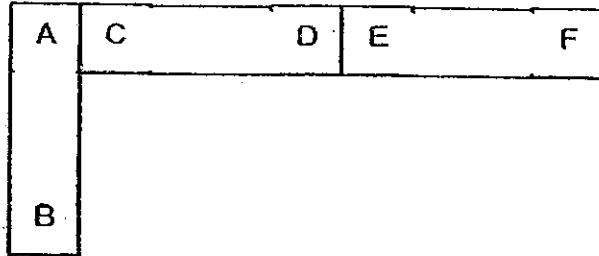

Which of the following pictures show the correct arrangement of the poles of the magnet?

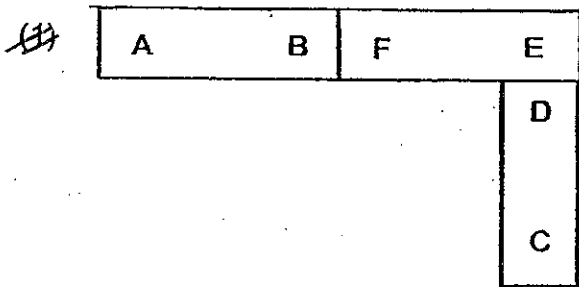

A

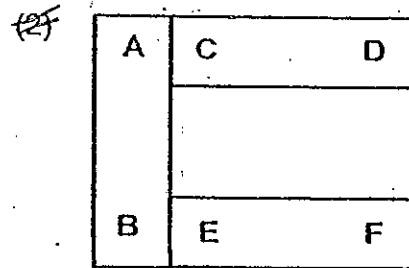

B

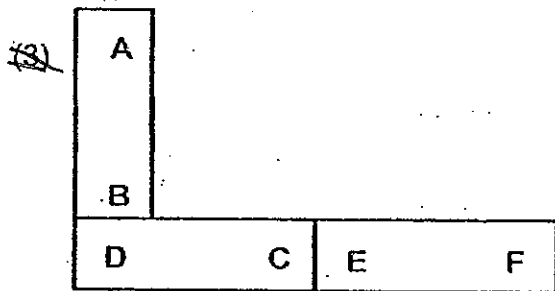

C

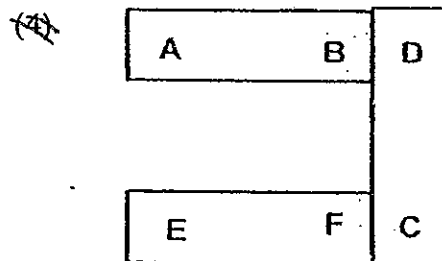

D

- (1) A and C only
 (3) B and C only

- (2) A and D only
 (4) B and D only

27. Bala kicked a ball. The diagram below shows the path of the ball after he has kicked it.

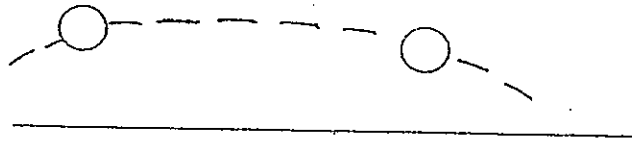

Which of the following shows the correct relationship between the height of the ball and the gravitational force?

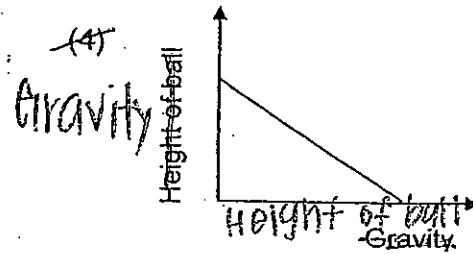
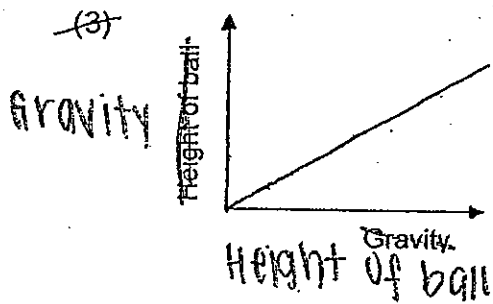
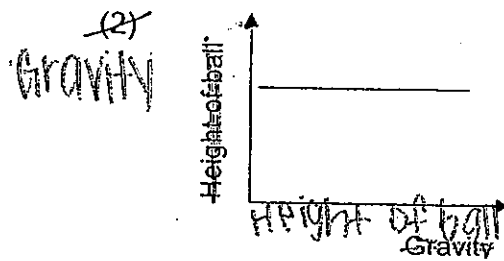
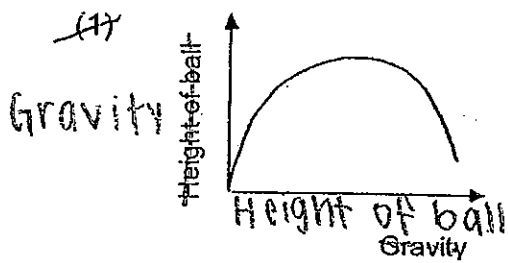

28. Nancy conducted an investigation. She wanted to find out the effect of the change in mass on the length of a spring. She measured the length of the spring when different masses of identical weights were placed on the pan in the set-up shown below.

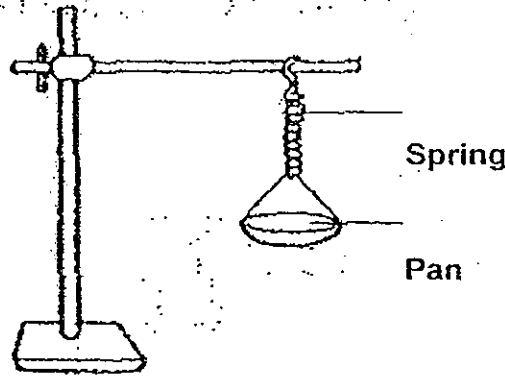

Nancy used her results to plot a graph as shown below.

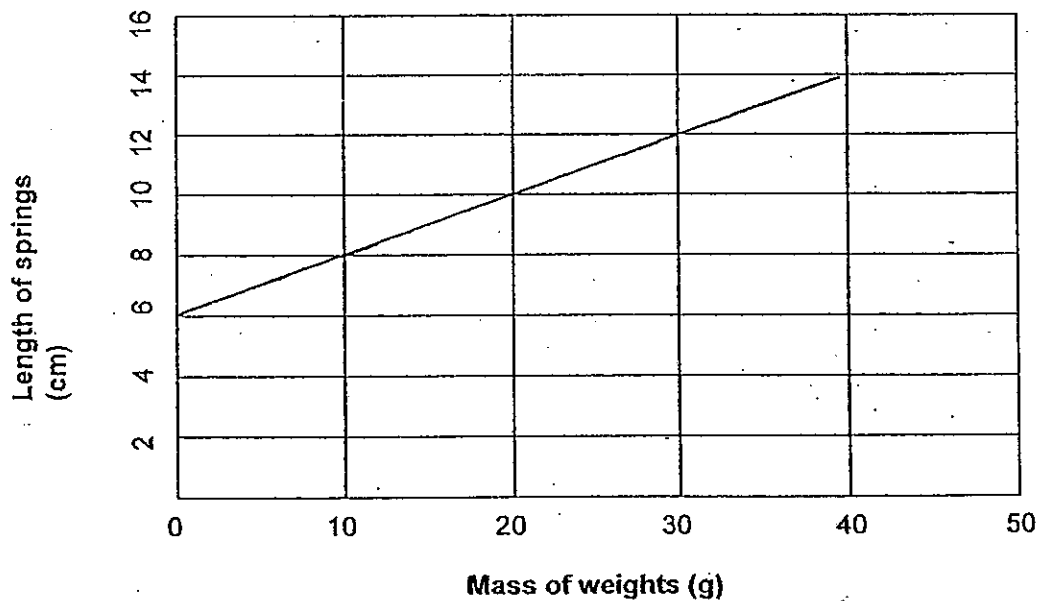

What was the extension of the spring when a 30g weight was placed on the pan?

- ~~(1)~~ 4 cm
~~(3)~~ 7 cm

- ~~(2)~~ 6 cm
~~(4)~~ 12 cm

29. 4 similar tiled floors were coated with different substances A, B, C and D. Sam carried out an experiment to find out how far a toy car can move over these tiled floors.

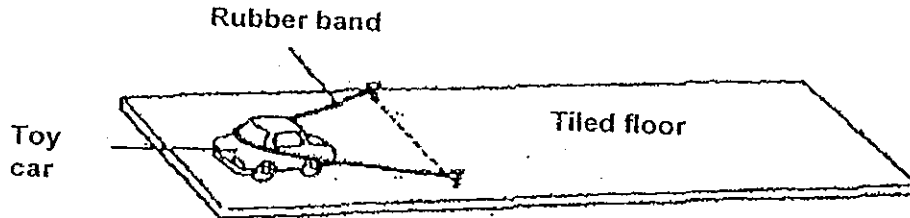

He measured the distance moved by the car over the different substances and recorded his results in the table below.

Tiled floor coated with substance	Distance moved by toy car (cm)
A	25
B	10
C	18
D	21

Which of the following shows the correct order of the surfaces, A, B, C and D when arranged from the smoothest to the roughest?

- ~~(1)~~ A, D, B, C ~~(2)~~ A, D, C, B
~~(3)~~ B, C, D, A ~~(4)~~ B, D, A, C
30. The diagram below shows 2 identical balls, X and Y, rolling towards each other at the same speed.

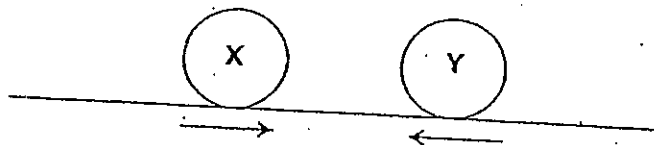

Which one of the following statements correctly describes what will happen when the 2 balls collide?

- ~~(1)~~ Balls X and Y will move back in opposite directions at different speed.
~~(2)~~ Balls X and Y will move back in opposite directions at the same speed.
~~(3)~~ Ball X will move back in the opposite direction, while Ball Y will stop moving when it hits Ball X.
~~(4)~~ Ball X will stop moving upon hitting Ball Y, while Ball Y will move back in the opposite direction.

End of Part 1



Rosyth School
Semestral Assessment 2 2010
STANDARD SCIENCE
Primary 5

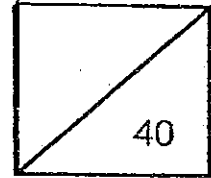

Total
Marks:

40

Name: _____

Class: Pr 5 _____

Register No. _____

Duration: 1 h 45 min

Date: 28 October 2010

Parent's Signature: _____

Booklet B

Instructions to Pupils:

1. Do not open the booklet until you are told to do so.
2. Follow all instructions carefully.
3. Answer all questions.
4. Write your answers in this booklet.

	Maximum	Marks Obtained
Booklet B	40 marks	

* This booklet consists of 15 pages.

This paper is not to be reproduced in part or whole without the permission of the Principal.

Part II (40 marks)

For questions 31 to 46, write your answers in this booklet. The number of marks available is shown in brackets [] at the end of each question or part question.

31. Xiao Han conducted an experiment and recorded her observations in a table as shown below.

Plant	Number of leaves on the plant	Amount of water in the beaker at the start of the experiment (ml)	Amount of water in the beaker at the end of the experiment (ml)
A	20	200	155
B	15	200	170
C	28	200	130
D	8	200	185

- (a) State the aim of Xiao Han's experiment. [1]

- (b) Describe how leaves in a plant get water. [2]

32. Mrs Lim started exercising slowly on a treadmill at first and gradually increases her speed. Using the heart rate monitoring bar, she measured her heart rate and her speed of running. She stopped running at 20 minutes.

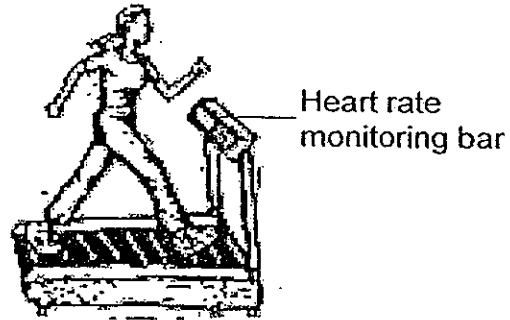

She represented her results in a graph as shown below.

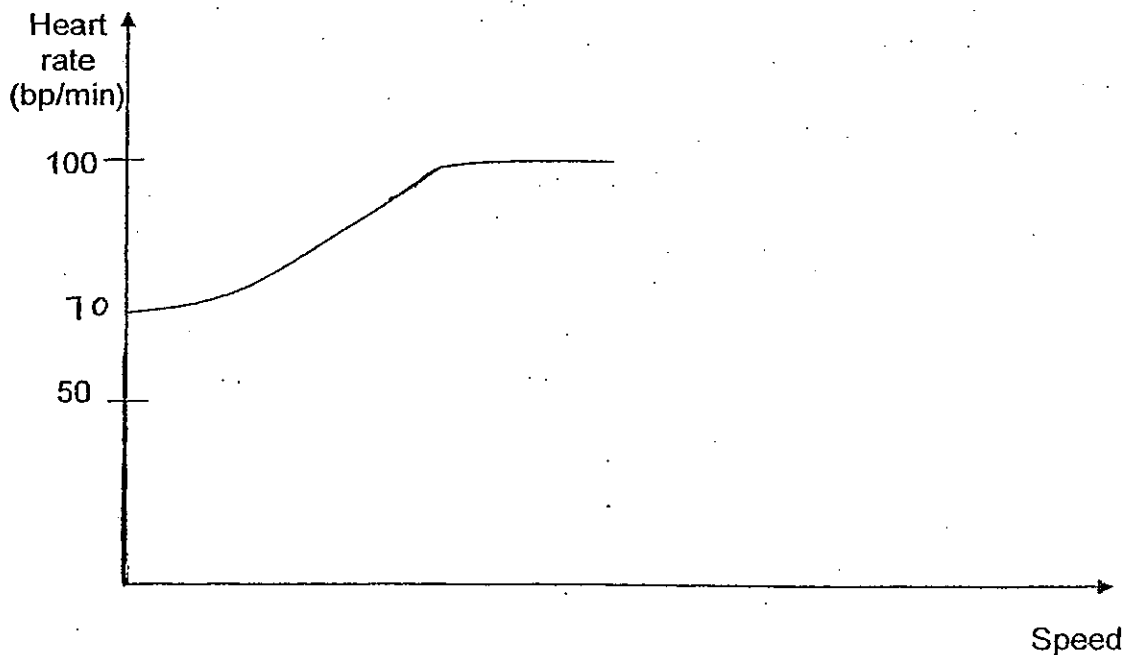

- (a) Describe the relationship between the heart rate and her speed of running.

[2]

- (b) What will be her heart rate after she has stopped to rest for 30 minutes?

[1]

33. The diagram below shows the flow of blood in the body of a man.

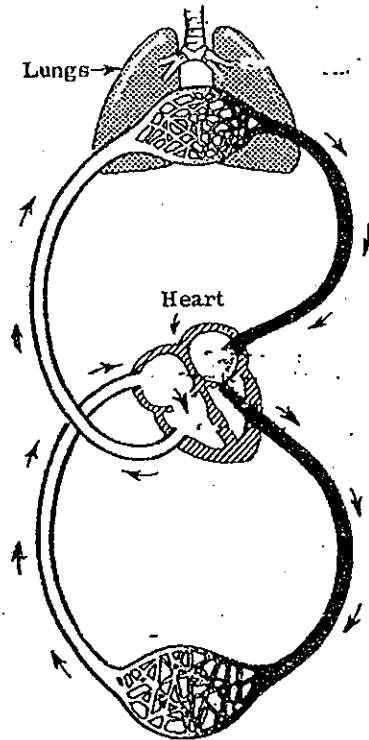

(a) Name the two systems as shown in the diagram above. [2]

(b) Describe how the systems work together to ensure survival. [2]

34. The diagram below shows a process that many cells undergo.

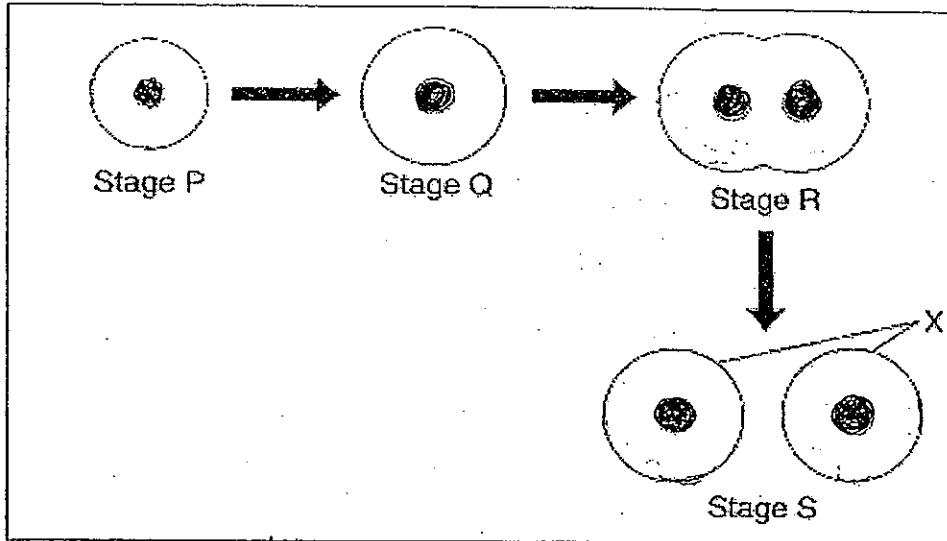

(a) State the life process that a cell undergoes from Stage P to Stage S. [1]

(b) Which part of the cell is responsible for the life process in (a)? [1]

(c) Why do cells need to undergo this process? [1]

35. The diagram below shows cells of an organism seen under the microscope.

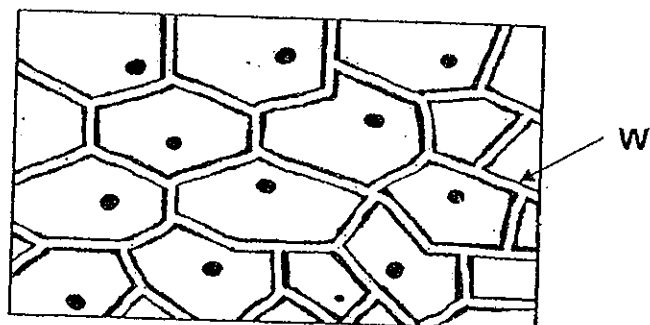

- (a) What is the function of the part 'W' in the cell? [1]

- (b) Give an example of an organism that you can find these cells in. [1]

36. Lucy found 4 organisms, P, Q, R and S, living in a habitat. She came up with the following information about the organisms.

Organism	Eats plants	Eats animals	Makes food
P	✓	✓	x
Q	✓	x	x
R	x	x	✓
S	x	✓	x

Using the information above, construct a food web about P, Q, R and S in the space provided. [2]

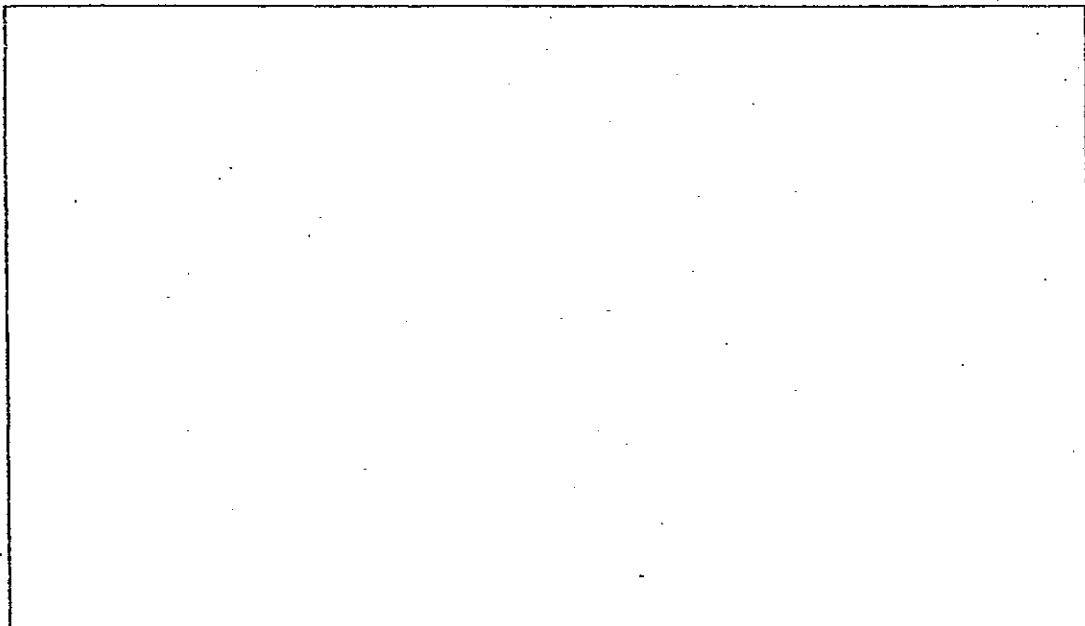

37. Zhenyi found the plant below growing around a support.

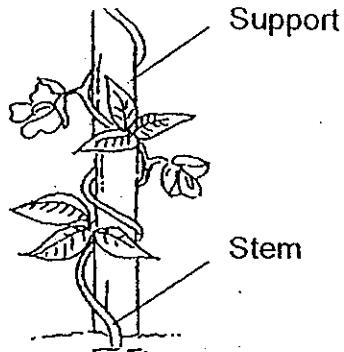

(a) Why does the plant need to grow on a support? [1]

(b) Zhenyi came across the plant shown below. It has needle-like leaves to survive in the desert.

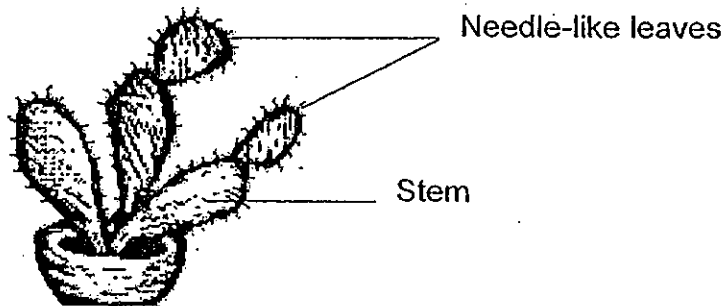

Using the picture above, state ONE other adaptation that the plant has in order to survive in the desert. [1]

38. Hubert recorded the following information about the stargazer fish that he came across.

The stargazer fish is a bony fish that lives in shallow waters. It prefers either to remain buried under the sand or mud or stay on the bottom of the sea or ocean bodies. When it buries itself in the sand or mud, the eyes and the mouth are the only two parts of the fish that are visible. It eats other fishes and crabs. Its spines can produce electricity and also deliver electric shocks.

- (a) Why do you think the stargazer fish buries itself such that only its eyes and mouth are visible? [1]
-

- (b) State another adaptation that Hubert recorded about the stargazer fish. [1]
-

39. Look at the diagram below which shows an ecosystem.



- (a) Decomposers play an important role in every ecosystem. Explain the role of decomposers in the ecosystem shown above. [2]

- (b) What is the role of the sun in this ecosystem? [1]

40. The diagram below shows the location of a river.

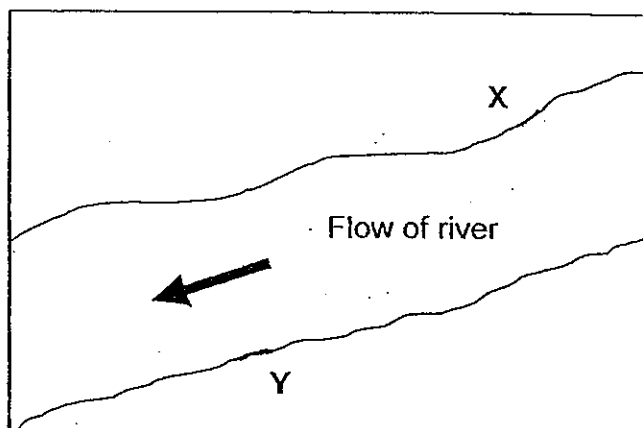

Arnold collected several water samples of the same volume near points X and Y. The percentage of 3 organisms, A, B and C were found in the water samples.

Arnold recorded his data in the table below.

Percentage of each organism in water samples collected	Point X	Point Y
Organism A	8	40
Organism B	31	17
Organism C	43	12

- (a) Arnold found a pollutant. Based on the above data, write down one effect that pollutant has on the organisms A, B and C. [1]

- (b) Arnold decided that the pollutant must have been discharged only at Point Y. Is it true? Give a reason. [1]

41. Some students set up an experiment as shown below. They filled the three beakers A, B and C with 50 ml of water. They also added 8 drops of chemicals X, Y and Z in the beakers A, B and C respectively. The containers were then left near a window.

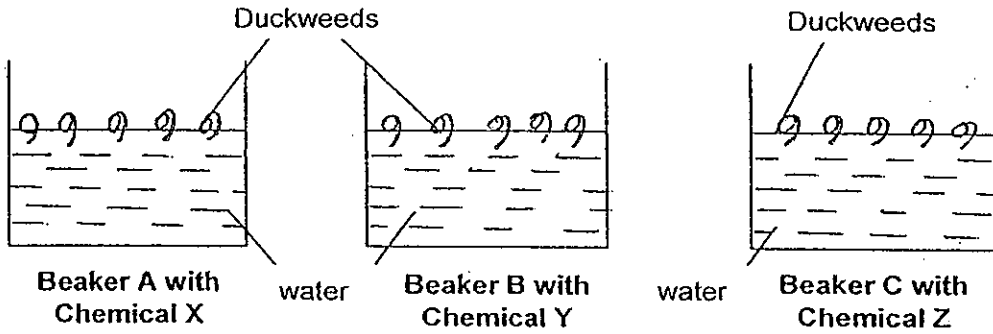

They counted the number of duckweeds that remained alive at the end of each day for a week. They recorded their data as shown in the table below.

	Number of duckweeds at the end of						
	Day 1	Day 2	Day 3	Day 4	Day 5	Day 6	Day 7
Beaker A	40	32	26	20	10	7	5
Beaker B	40	30	25	19	9	2	0
Beaker C	40	28	19	13	3	0	0

- (a) In the space provided, draw a control set-up for the experiment. [1]

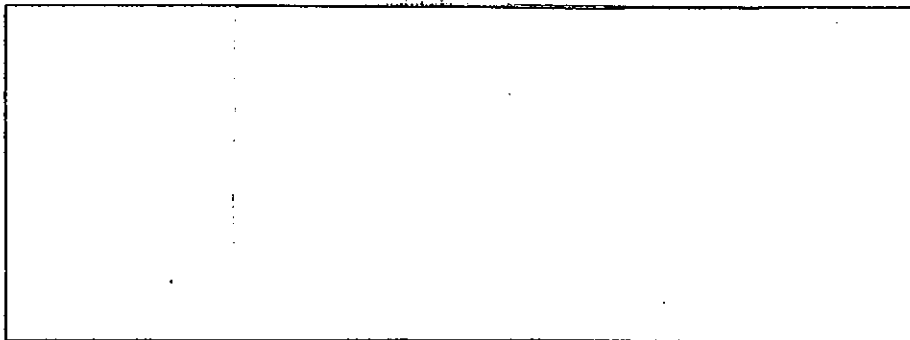

- (b) Based on the data given, what can the students conclude from this experiment about chemical Z? [1]

42. Michelle set up an electric circuit as shown in the diagram below. She made a 3-way switch using 4 thumbtacks, P, Q, R and S. A paper clip was connected to P and it could be moved to touch Q, R or S.

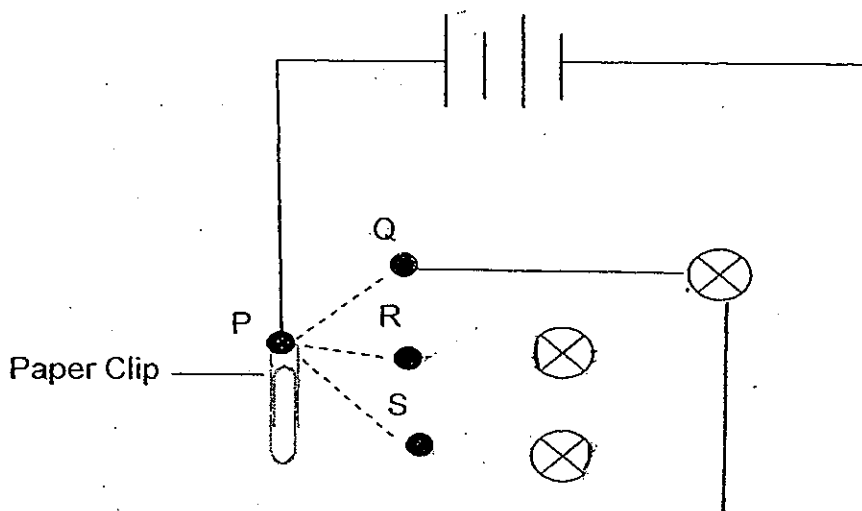

Draw 4 wires in the diagram to show how Michelle could connect the 3-way switch to the bulbs so that the paper clip could be moved to light up one of the bulbs. [2]

43. Power stations in Singapore burn fossil fuels to produce electricity. To reduce the usage of fossil fuels in producing electricity, the power stations also burn garbage.

(a) What is an advantage of burning garbage to produce electricity? [1]

(b) Suggest another alternative renewable source of energy to produce electricity. [1]

44. Ernest carried out an experiment to test 3 wires of different materials, A, B and C using the set-up below. The wires are of the same diameter and thickness.

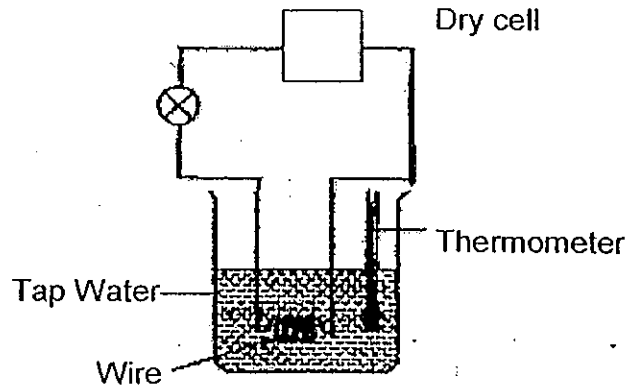

He measured the temperature of water for all the materials and recorded the results in a table as shown below.

Time interval (min)	Temperature of water (°C)		
	A	B	C
0	25	25	25
5	36	30	25
10	45	37	25
15	54	43	25
20	67	50	25
25	85	66	25

- (a) Which wire is a non-conductor of electricity? Support your choice [1]
-
- (b) Name one other variable that he must keep constant in order to have a fair test. [1]
-
- (c) State the difference between material A and B in terms of conductivity of heat. [1]
-

45. Devi moved a block of wood on two surfaces, a glass surface and a carpeted surface in the direction shown below.

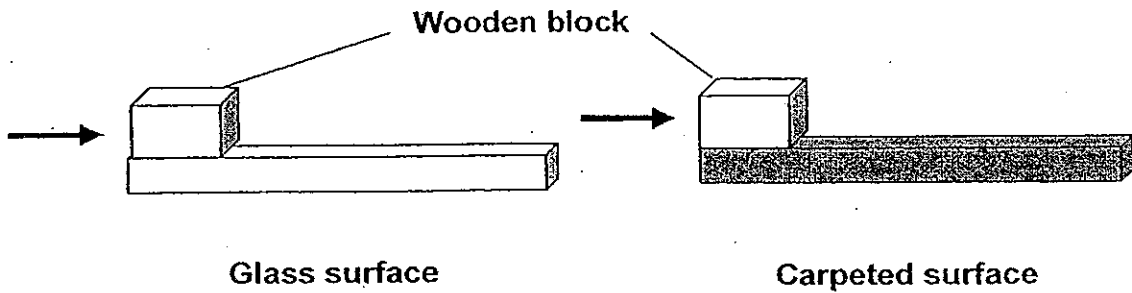

If she used the same amount of force to move the wooden block on both surfaces, on which surface will the wooden block travel further? Explain your answer. [2]

46. Rodney wanted to find out how the mass of loads will affect the extension of two springs A and B. He used the set-up shown below to carry out his investigation.

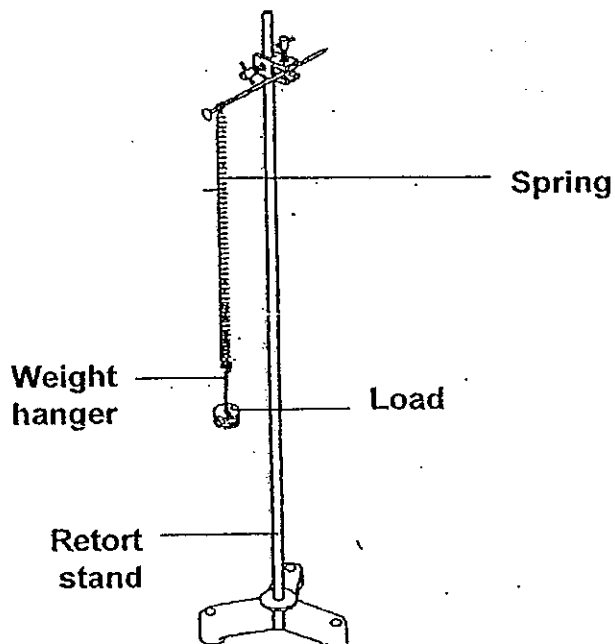

Question 46 is continued on page 15

He did the experiment using loads with different masses. He hung them on the weight hangers one at a time for each of the springs, A and B. He then recorded his results in the graph below.

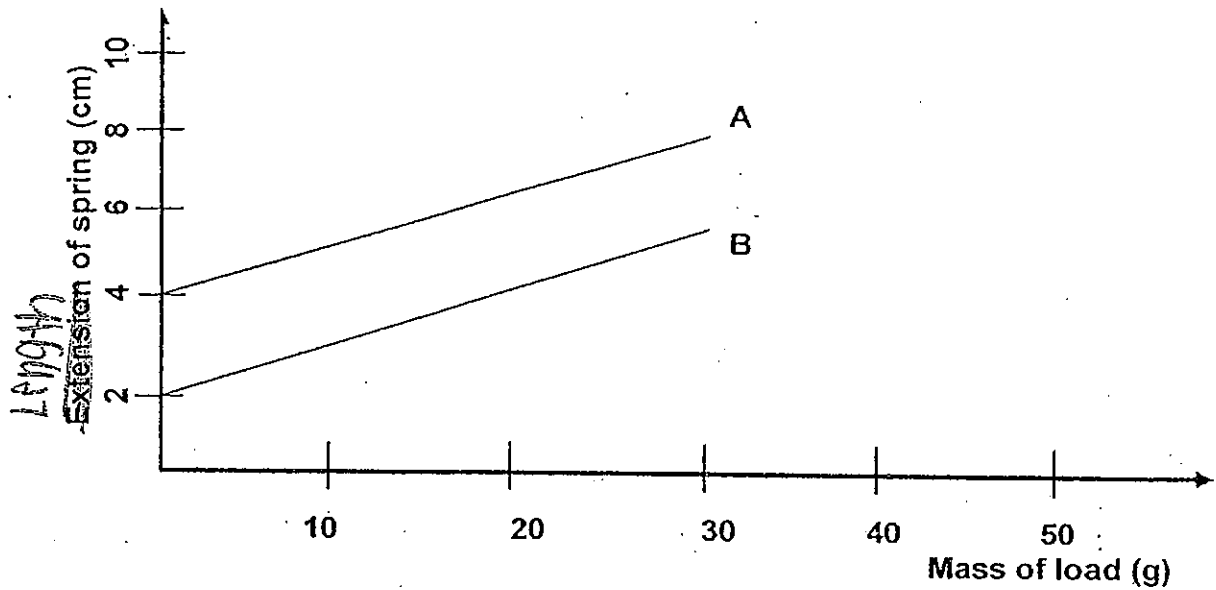

- (a) What is the relationship between the mass of the load and the pulling force? [1]

- (b) Do you think the elasticity of the two springs is the same or different? Explain why? [2]

End of Paper

Ans

EXAM PAPER 2010

SCHOOL : ROSYTH PRIMARY
SUBJECT : PRIMARY 5 SCIENCE

TERM : SA2

Q1	Q2	Q3	Q4	Q5	Q6	Q7	Q8	Q9	Q10	Q11	Q12	Q13	Q14	Q15	Q16	Q17
1	2	1	2	1	4	3	3	1	4	1	3	3	2	2	4	3

Q18	Q19	Q20	Q21	Q22	Q23	Q24	Q25	Q26	Q27	Q28	Q29	Q30
4	2	4	2	2	4	2	4	2	2	2	2	2

31)a)Xiao Han wants to find out whether the number of leaves on the plant will affect the amount of water taken in by the plant.

b)Water absorbed by the roots travel up to all the other parts of the plant such as the leaves through the xylem tubes in the stem.

32)a)The faster she runs, the faster her heart rate. After that, the heart rate remains constant.

b)70bp/min.

33)a)The human respiratory system and the human circulatory system.

b)The lungs take in oxygen which is transported in the body by the circulatory system, which removes carbon dioxide and the lungs help to remove it from the body.

34)a)Cell Division/Binary Fission.

b)The nucleus.

c)To replace old and damaged cells.

35)a)Part 'W' is partially permeable and allows only certain substances such as water to pass through.

b)Onion, sunflower.

36)

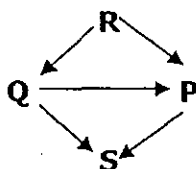

37)a)The plant has a weak stem which does not enable it to grow upright and reach for maximum sunlight.

b)The plant has a thick swollen stem which stores water.

38)a) It will be difficult for the prey to notice it but the stargazer can notice its prey and easily open its mouth to it feed.

b) Hubert also recorded that the stargazer fish has spines which can produce electricity and deliver electric shock.

39)a) After the organisms die, the decomposers break them down into simpler substance which are later returned to the soil as nutrients for the other plants.

b) The sun is a source of energy.

40)a) The chemical caused organism A to increase, but caused organism B and C to decrease.

b) No. The pollutant could have been discharged at point X and flowed downstream, also affecting the organisms at point Y.

41)a)

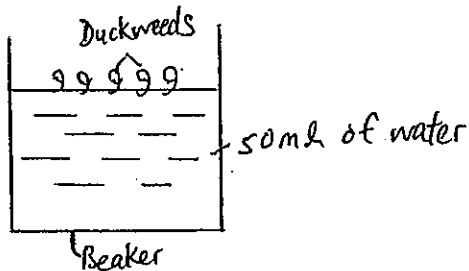

b) The students can conclude that chemical Z had the worst effect on the duckweeds.

42)

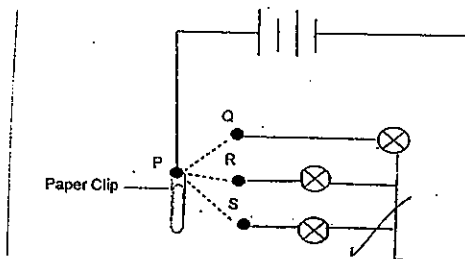

43)a) Conserves land needed to bury the garbage/conserves fossil fuels which are not renewable.

b) Solar Energy, Hydroelectricity, Wind Energy, Wind/Water/Sun.

44)a) Wire C. Its temperature remained the same as electric current cannot flow.

b) Voltage of dry cells.

c) material A is a better conductor of heat than material B.

45) The wooden block will travel further on the glass surface. The glass surface is smoother than the carpeted surface, so there is less friction between the wooden block and the glass surface.

46)a) The greater the mass of the load, the greater the pulling force.

b) For same amount of load, the extension is the same./ The rate of extension is the same.