

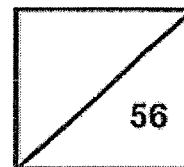

Rosyth School
End-of-Year Examination
SCIENCE
Primary 5

Name: _____

Total
Marks:



Class: Pr 5- _____ Register No. _____

Total time for Booklets A and B: 1 h 45 min

Booklet A

Instructions to Pupils:

1. Do not open the booklet until you are told to do so.
2. Follow all instructions carefully.
3. This paper consists of 2 booklets, Booklet A and Booklet B.
4. For questions 1 to 28 in Booklet A, shade the correct ovals on the Optical Answer Sheet (OAS) provided using a 2B pencil.

* This booklet consists of **21** printed pages (including this cover page).

For each question from 1 to 28, four options are given. One of them is the correct answer. Make your choice (1, 2, 3 or 4). **Shade the correct oval (1, 2, 3 or 4) on the Optical Answer Sheet.** (56 Marks)

1 Which one of the following parts of a cell supports and protects the cell?

- (1) nucleus
- (2) cell wall
- (3) cytoplasm
- (4) cell membrane

2 The diagram below shows a cell with parts A, B, C and D.

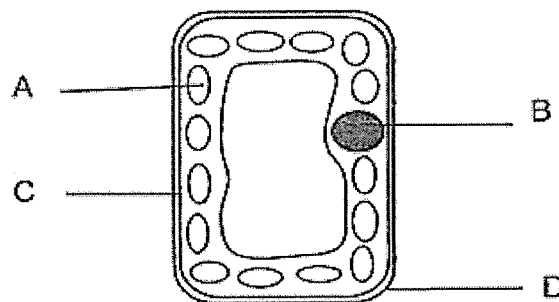

Four students made some statements as shown below.

Amy: All plant cells have part A.

Bill: The cell is a plant cell as it has part C.

Cassy: The cell is an animal cell as it has part D.

Dawn: The cell needs part B as it controls all its activities.

Which of the students have made the correct statement?

- (1) Amy
- (2) Bill
- (3) Cassy
- (4) Dawn

- 3 A botanist wanted to create a new breed of hibiscus plant with flowers that will glow in the dark. She obtained the genetic information from an animal cell and inserted it into a hibiscus plant cell.

The diagrams below show two cells.

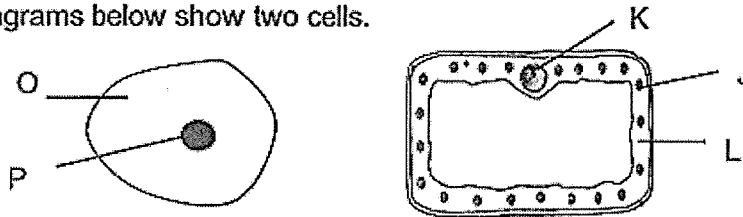

Which of the following will the botanist need to carry out in order to achieve his aim?

	Obtained genetic information from part	Transfer genetic information into part
(1)	O	J
(2)	P	K
(3)	L	P
(4)	K	O

- 4 The diagram below shows a plant.

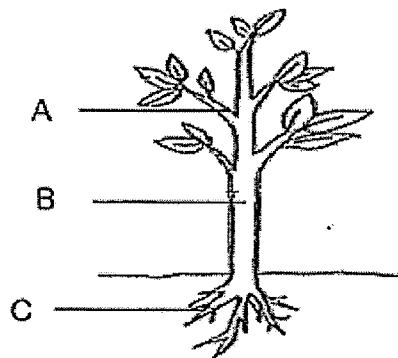

At which part(s) of the plant, A, B and C, is/are water-carrying tubes found?

- (1) A only
 (2) B only
 (3) B and C only
 (4) A, B and C

- 5 Study the two set-ups, E and F, below. Lee Ping remove some of the roots from one of the plants. She then recorded the water level at regular time intervals.

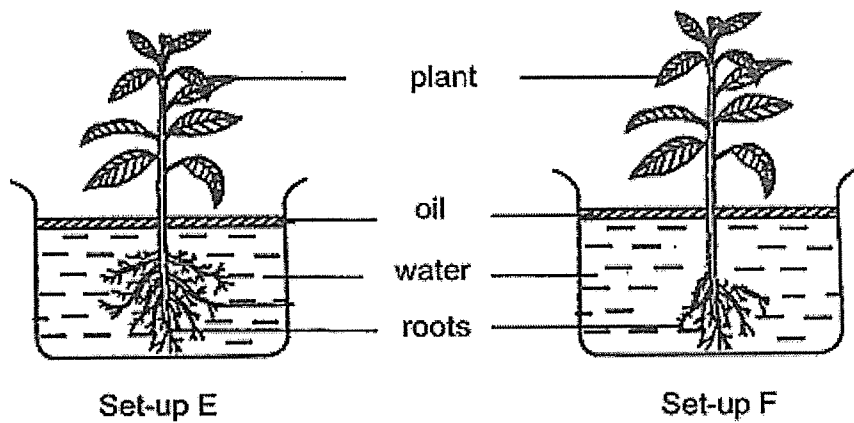

The results obtained are as shown.

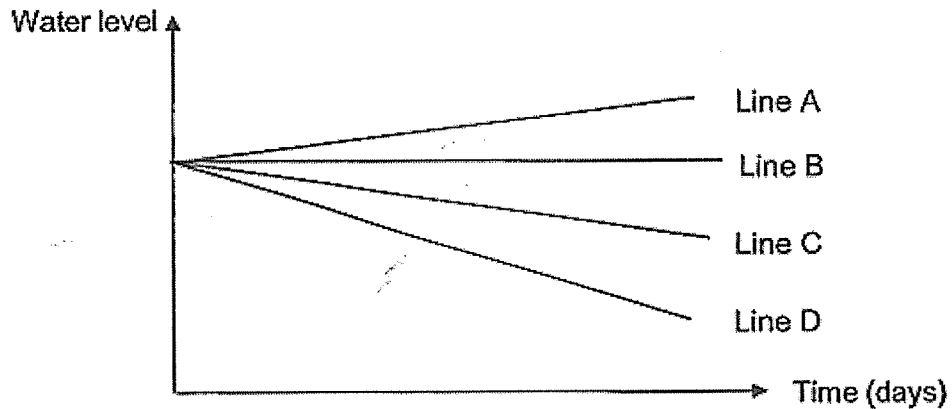

Which line, A, B, C or D, represents the results for set-ups, E and F?

	Set-up E	Set-up F
(1)	D	B
(2)	C	A
(3)	D	C
(4)	C	D

6 Bryan set up an experiment using two similar plants, X and Y.

He recorded the variables in the table as shown below.

Variables	Plant X	Plant Y
location	field	field
length of stem	20 cm	14 cm
number of leaves	6	6
volume of water in the beaker at the start of the experiment	500 ml	500 ml

He measured the volume of water in the beaker at the end of the experiment.

The aim of the experiment is to find out if the _____.

- (1) length of stem affects the number of leaves
- (2) location of plant affects the volume of water taken in by the plant
- (3) number of leaves affects the volume of water taken in by the plant
- (4) length of the stem affects the volume of water taken in by the plant

- 7 The pie chart below shows the composition of gases in the air.

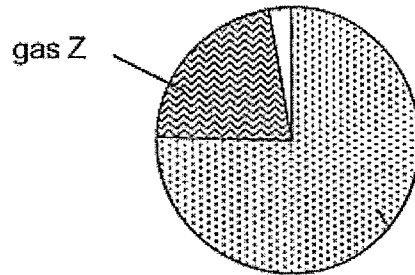

Which of the following are true of gas Z?

- A: Needed for respiration
- B: Produced during burning
- C: Needed for photosynthesis
- D: Produced during photosynthesis

- (1) A and C only
- (2) A and D only
- (3) B and D only
- (4) A, B, C and D

- 8 Some children are having their skipping lesson as shown below.

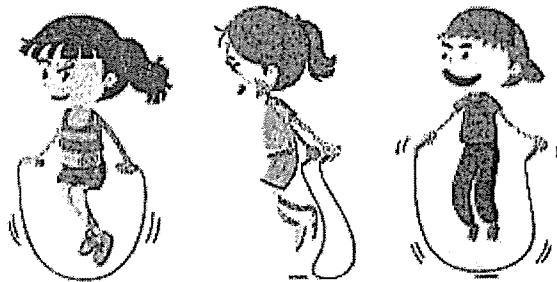

Which statement correctly explains what happens when the children are skipping?

- (1) Heart rate increases to take in more air
- (2) Heart rate increases to pump more blood per minute.
- (3) Breathing rate increases to take in more carbon dioxide.
- (4) Breathing rate increases to remove more oxygen per minute.

9 Which one of the following shows how the systems works together to transport oxygen and digested food to the muscles?

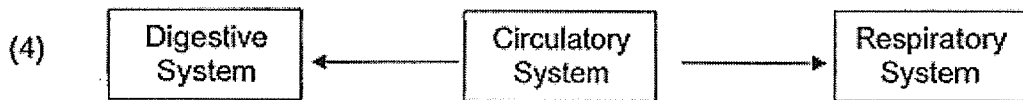
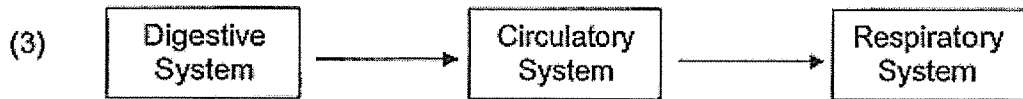
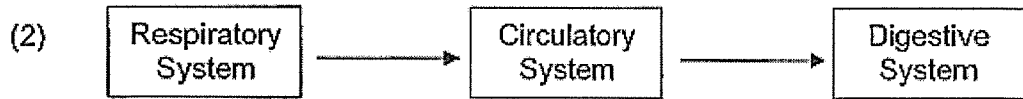
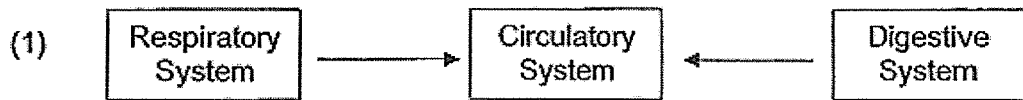

- 10 Adam, Keith and Tom wanted to measure the volume of air they breathe out using the set-up shown below.

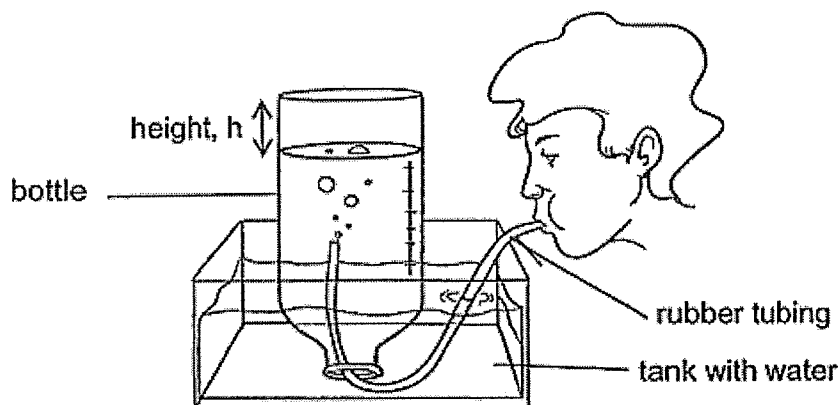

The bottle was filled the water fully in the beginning. Adam took a deep breath and blew as much air as possible through the rubber tubing. The height (h) of air in the bottle was measured. The experiment was repeated by Keith and Tom respectively.

The results of their experiment are shown in the table below.

Students	Height, h (cm)
Adam	15
Keith	26
Tom	21

Which of the following statements is correct?

- (1) Tom has the greatest lung capacity.
- (2) Adam exhaled the least amount of air.
- (3) Adam displaced more water in the bottle than Keith.
- (4) Keith could hold the smallest amount of air in his lungs.

- 11 The diagram shows the male and female reproductive systems in humans.

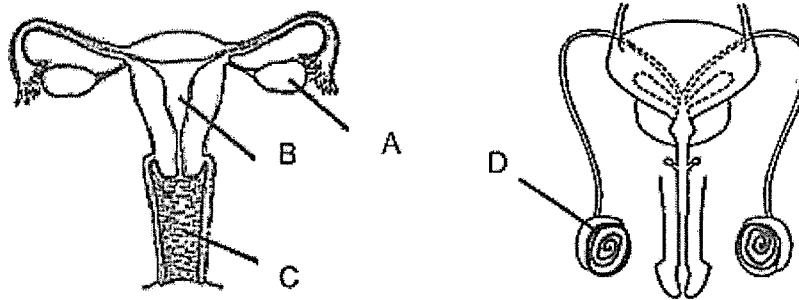

Which one of the following parts corresponds to the correct function?

	Part	Function
(1)	A	produces sperms
(2)	B	where the baby develops
(3)	C	where the fertilised egg attaches to
(4)	D	produces eggs

- 12 The diagram below shows a cross-section of fruit P.

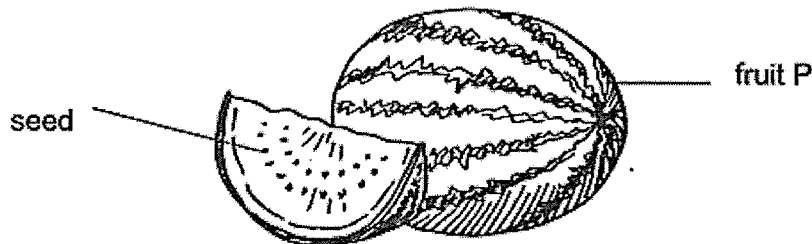

Which one of the following statements is most likely to be true about the flower that the fruit was produced from?

- (1) It has many ovaries.
- (2) It has female parts only.
- (3) It is pollinated by animals.
- (4) It has been pollinated and fertilised.

- 13 Julia wants to find out the effect of overcrowding on the growth of the balsam plant.

Study the table below.

Pot	Number of balsam seeds	Type of soil	Size of pot
A	10	garden	big
B	5	garden	small
C	5	sandy	medium
D	5	garden	medium
E	5	garden	big
F	3	sandy	small

Which three pots given below should she set up to carry out a fair test?

- (1) A, B and D
- (2) A, C and F
- (3) B, C and E
- (4) B, D and E

- 14 Paul set up an experiment as shown below.

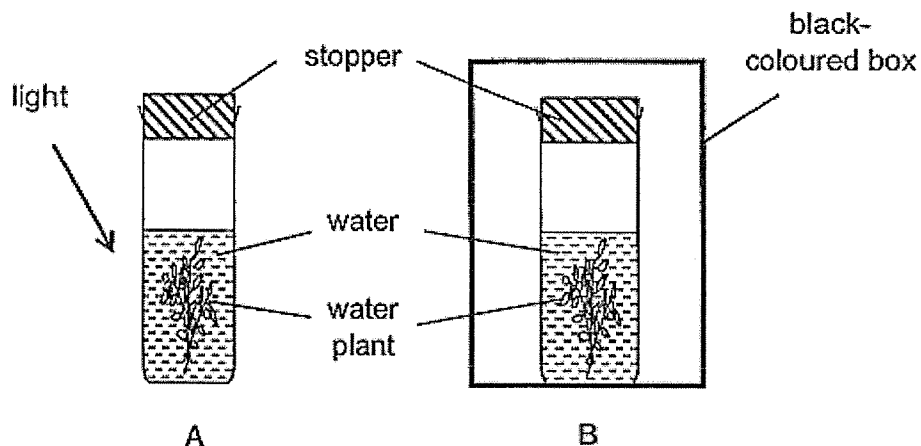

Which of the following shows the possible change in carbon dioxide levels in the test tubes after a few hours?

Level of carbon dioxide in set-up	
A	B
(1) Increase	Decrease
(2) Decrease	Increase
(3) Decrease	Decrease
(4) Increase	No change

- 15 A, B, C and D are parts of an electric bulb as shown below.

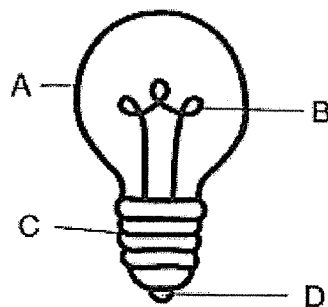

Which parts of the electric bulb conduct electricity?

- (1) A and B only
- (2) B and C only
- (3) C and D only
- (4) B, C and D only

16 Study the four circuits, W, X, Y and Z, as shown below.

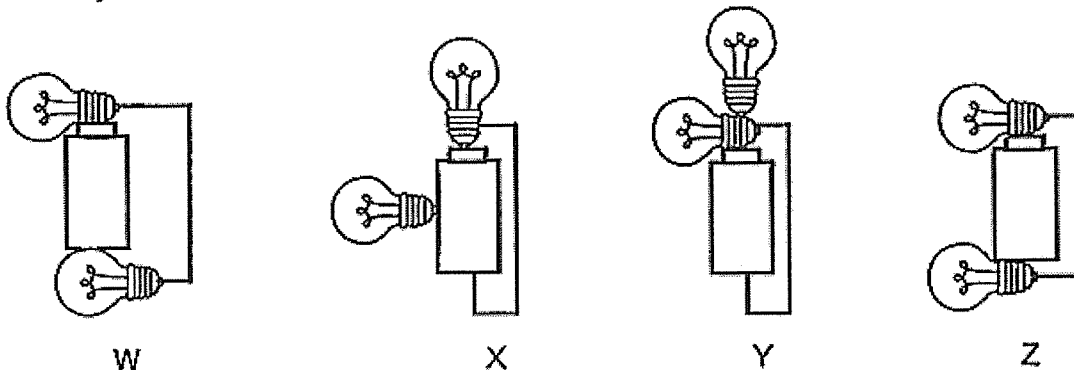

In which one of the following circuit(s) will both bulbs light up?

- (1) Z only
 - (2) W and Z only
 - (3) X and Y only
 - (4) W, X and Y only
- 17 James set up an electric circuit as shown below using identical light bulbs. He placed three objects at positions R, S and T. One of the objects is an insulator of electricity while the rest are conductors of electricity.

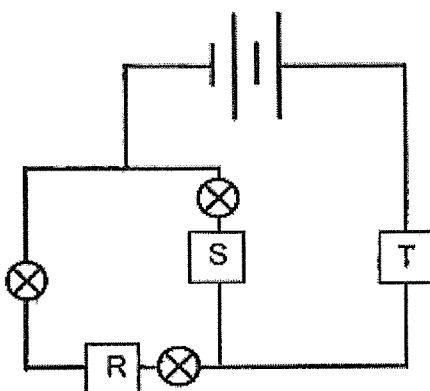

What is the smallest number of light bulbs that can light up?

- (1) zero
- (2) one
- (3) two
- (4) three

- 18 Emily studied the electrical circuit of a fan and wanted to recreate the circuit. However, he did not have the required parts for the circuit and he created a modified electrical circuit for a fan as shown below.

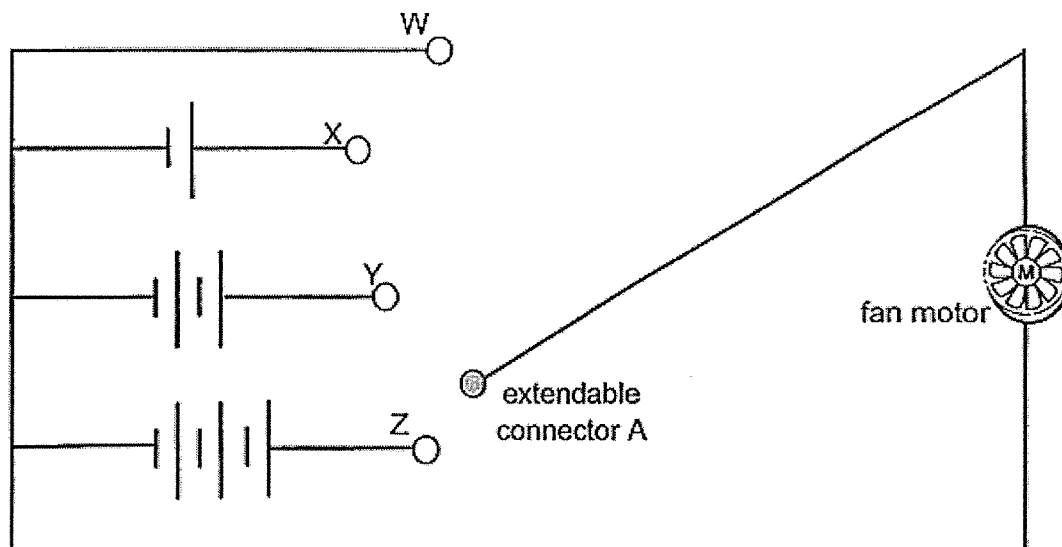

Connector A can be extended to reach all four points, W, X, Y and Z. When connector A is placed at one of the points, W, X, Y or Z, an observation can be made.

Which of the following conclusions can be correctly made from the observation of the electrical set-up above?

- (1) The fan will not work as the circuit is always open.
- (2) The fan is switched on for all connections made to points W, X, Y and Z.
- (3) The speed of the fan can be controlled by switching connections made to points X, Y and Z.
- (4) As the number of batteries increases, the speed of the fan remains the same.

- 19 Mary heated a beaker of water on the stove. The water boiled and bubbles were seen rising to the surface of the water.

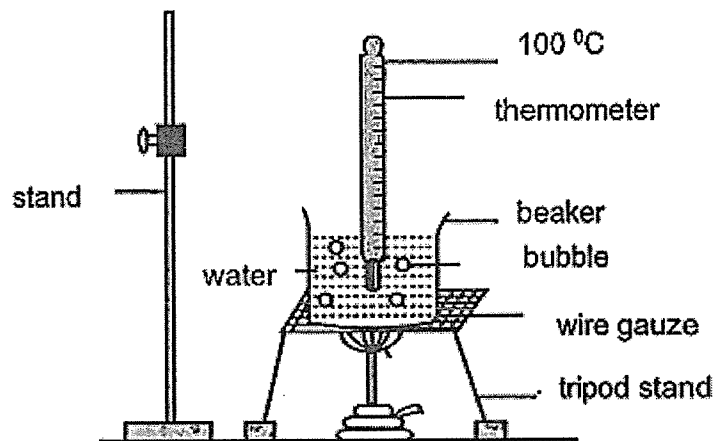









What is in the bubbles?

- (1) water
- (2) oxygen
- (3) water vapour
- (4) carbon dioxide

20 Study the weather report of four days.

Which day is most suitable to hang wet clothes outside in the morning to be dried by the end of afternoon?

	Day	Morning	Afternoon
(1)	Sunday	 Cloudy	 Sunny
(2)	Monday	 Thunderstorm with strong wind	 Rainy
(3)	Tuesday	 Strong wind	 Sunny
(4)	Wednesday	 Very sunny	 Rainy

- 21 Alan and his friends made the following statements about the water cycle.
- A: Water evaporates at a fixed temperature.
 - B: Water gains heat during evaporation and condensation.
 - C: When water vapour condenses, it changes from gaseous to liquid state.

Which of the following statement(s) about the water cycle is/are correct?

- (1) A only
 - (2) C only
 - (3) A and B only
 - (4) B and C only
- 22 Substance Z is a solid at 40°C and a liquid at 250°C.

Which one of the following is possible?

	Melting Point of Z (°C)	Boiling Point of Z (°C)
(1)	30	150
(2)	30	350
(3)	50	150
(4)	50	350

- 23 A glass bottle of cold water was taken out of the refrigerator and placed on top of a weighing scale at room temperature. The reading on the scale is shown below.

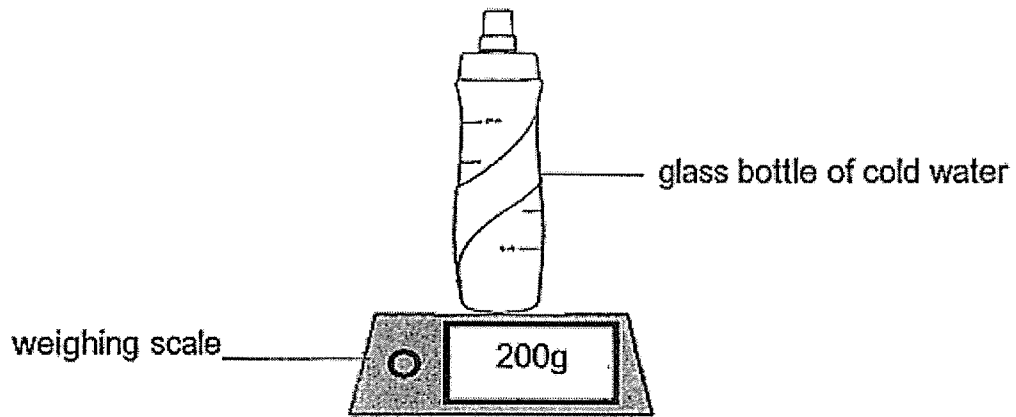

Which of the following correctly shows the changes in the reading on the scale and the temperature of the cold water after some time?

	Reading on scale (g)	Temperature of cold water ($^{\circ}\text{C}$)
(1)	200g	increase
(2)	more than 200g	increase
(3)	200g	decrease
(4)	more than 200g	remain the same

- 24 Eugene bought a terrarium with plants in a layer of wet soil in an airtight container. He placed it by a window. He observed that there were more plants, and they were growing well after some time as shown below.

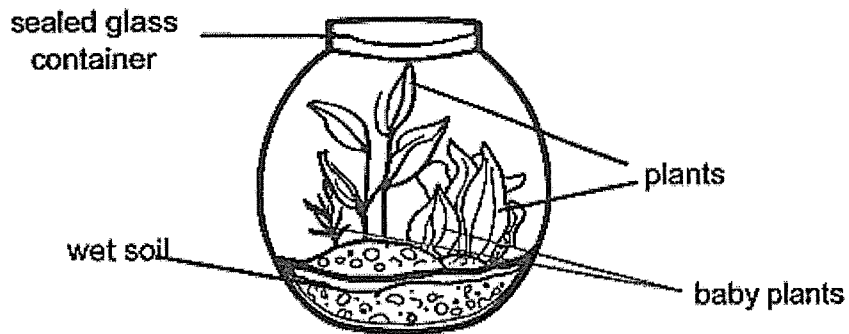

Which of the processes took place in the terrarium?

- A: Evaporation
- B: Reproduction
- C: Condensation
- D: Photosynthesis

- (1) A and C only
- (2) B and D only
- (3) A, C and D only
- (4) A, B, C and D

- 25 Rita carried out an experiment where she filled a beaker with water to its brim. Then, she put a stone into it and observed that water overflowed as shown in the diagram below.

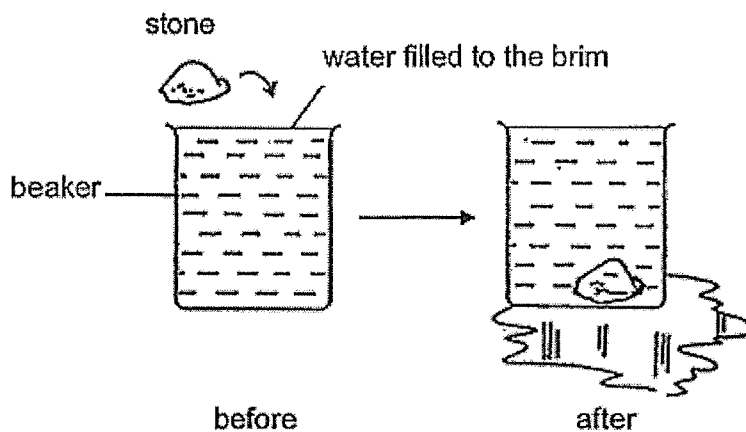

The water overflowed because _____.

- (1) stone has mass
- (2) stone occupies space
- (3) stone has definite shape
- (4) water has indefinite shape

26 Study the diagram below.

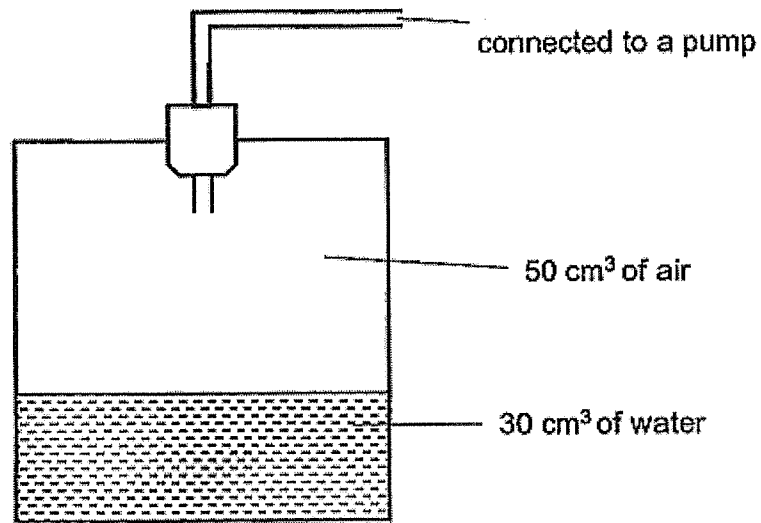

The volume of the container was 80 cm³. Using the pump, another 10 cm³ of water and 10 cm³ of air were added into the container.

What is the final volume of air in the container?

- (1) 30 cm³
- (2) 40 cm³
- (3) 50 cm³
- (4) 60 cm³

27 Which of the following is not a source of heat?

- (1) the sun
- (2) a campfire
- (3) a lighted bulb
- (4) a winter jacket

28 The diagram below shows a conveyor belt which separates two different types of beads, A and B.

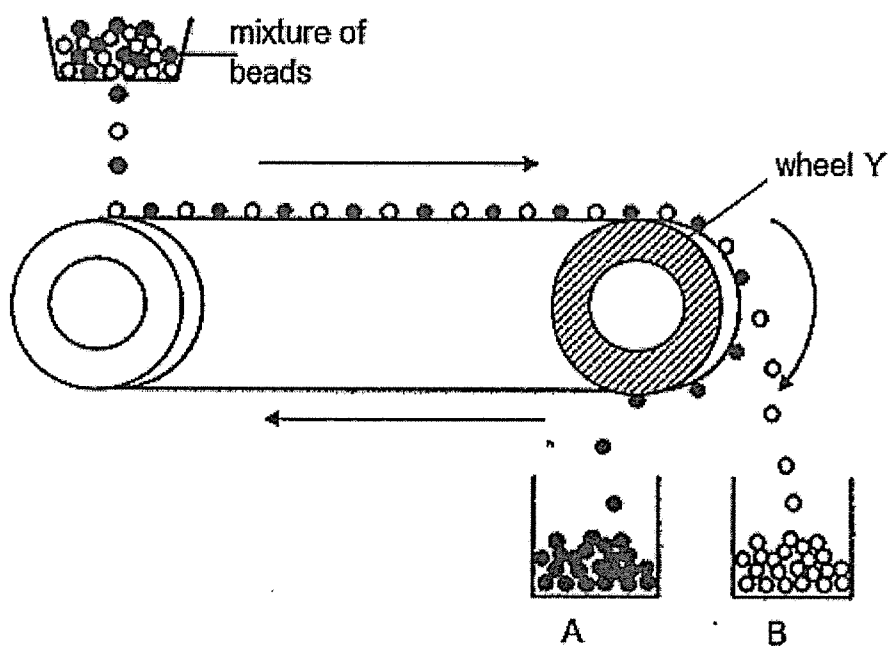

To separate the mixture of beads into containers A and B, which of the following is correct?

	wheel Y	material of beads A	material of beads B
(1)	steel	iron	plastic
(2)	magnet	plastic	iron
(3)	iron	magnet	steel
(4)	magnet	iron	plastic

GO TO BOOKLET B



**Rosyth School
End-of-Year Examination**

SCIENCE

Primary 5

Name: _____

Total

Marks:

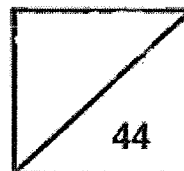

Class: Pr 5- _____ Register No. _____

Parent's Signature: _____

Total time for booklets A & B: 1h 45min

Booklet B

Instructions to Pupils:

1. For questions 29 to 40, write your answers in the spaces given in this booklet.

	Maximum marks	Marks Obtained
Booklet A	56	
Booklet B	44	
Total	100	

* This booklet consists of **17** printed pages (including this cover page).

For questions 29 to 40, write your answers in the space provided.

(44 Marks)

- 29 Bill observed two organisms, S and T, that live in a pond. S and T can only be observed by using a microscope.

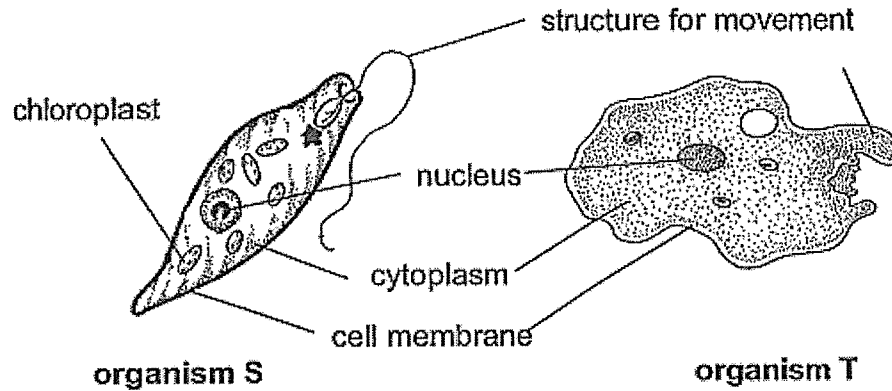

- (a) Based on the diagrams above, put a tick (✓) in the boxes below to indicate if the following inferences are true or false. [2]

	Statement	True	False
(i)	Both organisms are animal cells.		
(ii)	Both organisms can make food.		
(iii)	Both organisms can move in water.		
(iv)	Both organisms are microscopic.		

- (b) Bill made a statement that as we grow taller, our cells grow bigger in size. Is Bill's statement correct? Explain your answer. [1]

- 30 Gladys carried out an experiment using part of the stem of a plant as shown below. She wanted to make two cuts on the stem as indicated below. The water and food-carrying tubes were removed at section A while the food-carrying tube was removed at section B.

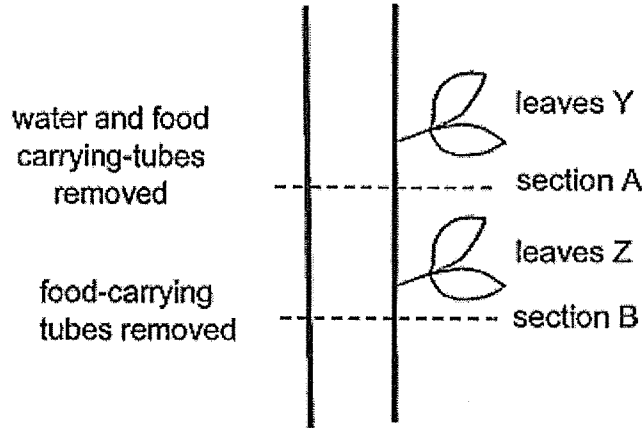

- (a) Based on Gladys' experiment, what would she observe about leaves Y and Z? [2]

(i) Leaves Y: _____

(ii) Leaves Z: _____

Q30 continued on the next page

Removing food-carrying tubes from the stem of trees is a practice in fruit production. Farmers do this in fruit farming to produce bigger fruit.

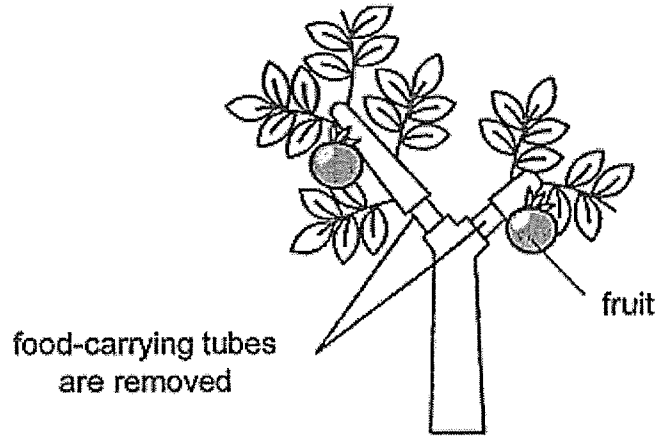

- (b) Explain how the removal of food-carrying tubes from the stem of trees enable fruits to be bigger. [2]

- 31 Diagram 1 below shows the transport of two substances from one part of the plant to another.

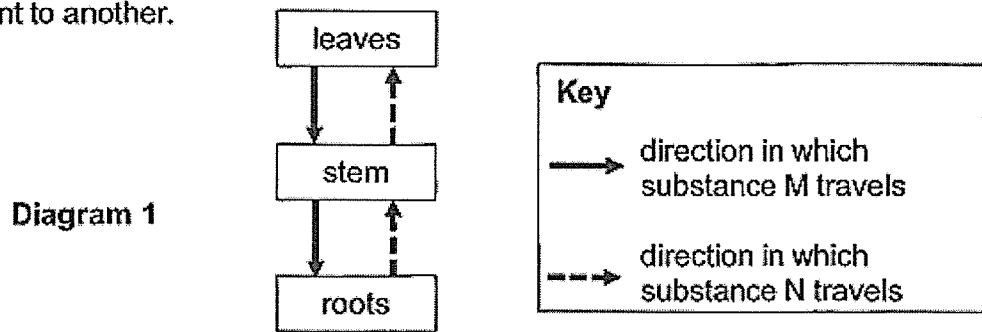

- (a) Identify substance M. [1]

- (b) What happens to substance N when it reaches the leaves? [1]

Diagram 2 below shows the human circulatory system.

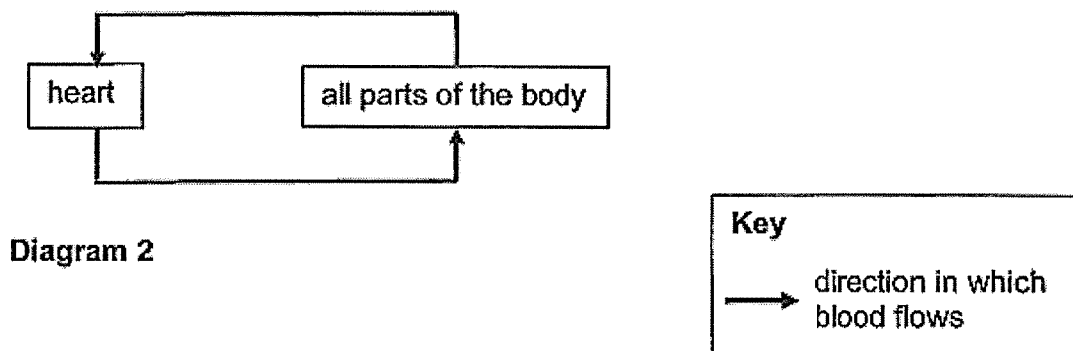

Compare Diagrams 1 and 2.

- (c) State the difference in the direction in which water is transported in plants and blood is transported in humans. [2]

- 32 A fruit is formed from the flower of plant B. Bees help in process M of the formation of a fruit.

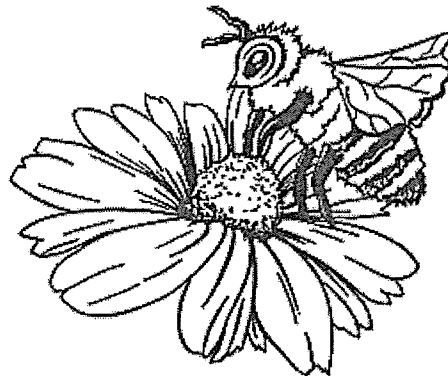

flower of plant B

The diagram below shows how a fruit is formed from the flower of plant B.

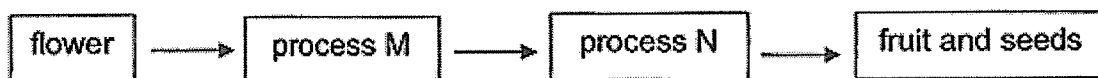

- (a) Describe process M [1]

- (b) Complete the table below to show which parts of the flower will develop into the fruit and the seed. [1]

		Flower Part
(i)	fruit	
(ii)	seed	

Q32 continued on next page

Winnie took the seeds of the fruit from adult plant B and germinated them under favourable conditions.

Fruit from adult plant B at its early stage of development is green in order to blend in with its surroundings. However, it turns red when it is fully developed.

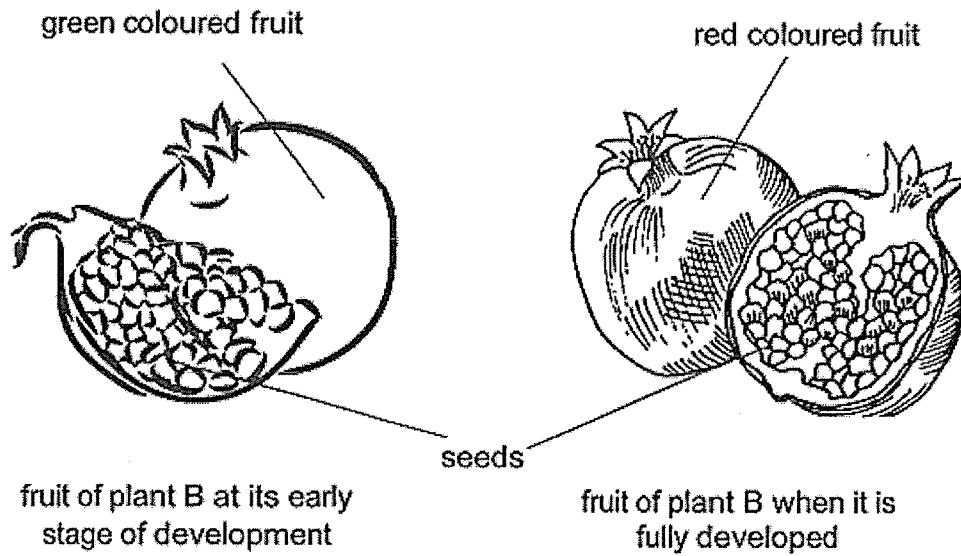

- (c) Explain how the change in colour of the fruit increases the chances of dispersal of its seeds. [2]

33 Study the two graphs shown below.

Light intensity

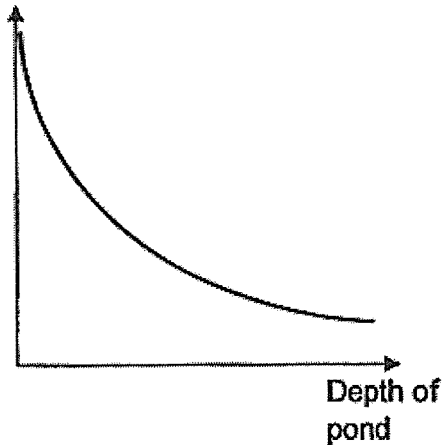

Graph J

Number of fully submerged green plants

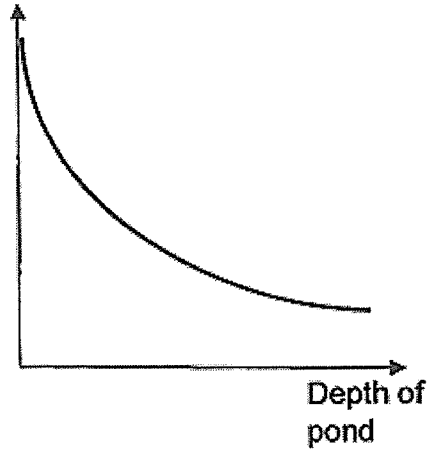

Graph K

Graph J shows how light intensity changes with the depth of the pond.

Graph K shows how the number of fully submerged green plants changes with the depth of the pond.

- (a) Based on the graphs above, what is the relationship between the number of fully submerged green plants and the light intensity? [1]

- (b) Explain your answer in (a). [1]

34 Kenny placed set-ups P and Q below under the sunlight for four hours.

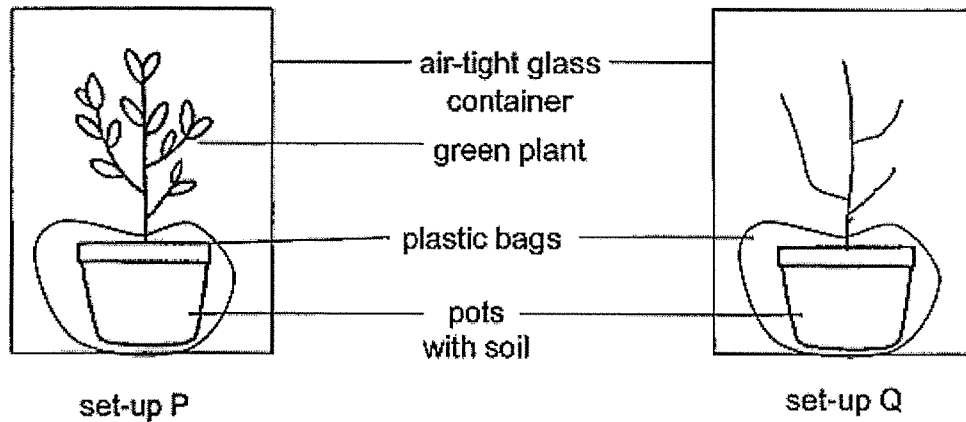

He measured and recorded the amount of gases in the glass containers at the beginning and end of the experiment.

- (a) Complete the table below to show the changes in the amount of gases in the two glass containers with the words 'increased', 'decreased' or 'no change'. [2]

	Set-up P	Set-up Q
Oxygen		
Carbon dioxide		

- (b) What was Kenny trying to find out in his experiment? [1]

- (c) Why did Kenny cover the pots with plastic bags in the set-ups? [1]

- (d) Would Kenny's results be different if he placed set-up P in an enclosed black box? Explain your answer. [1]

35 Aaron designed a wire maze game. A player has to move the loop from point A to point B without letting the loop touch the wire maze. If the loop touches the wire maze, the bulb and buzzer are turned on.

(a) Complete the circuit below by adding wires to connect the bulb and buzzer. The bulb and buzzer should work even if one of them is faulty. [2]

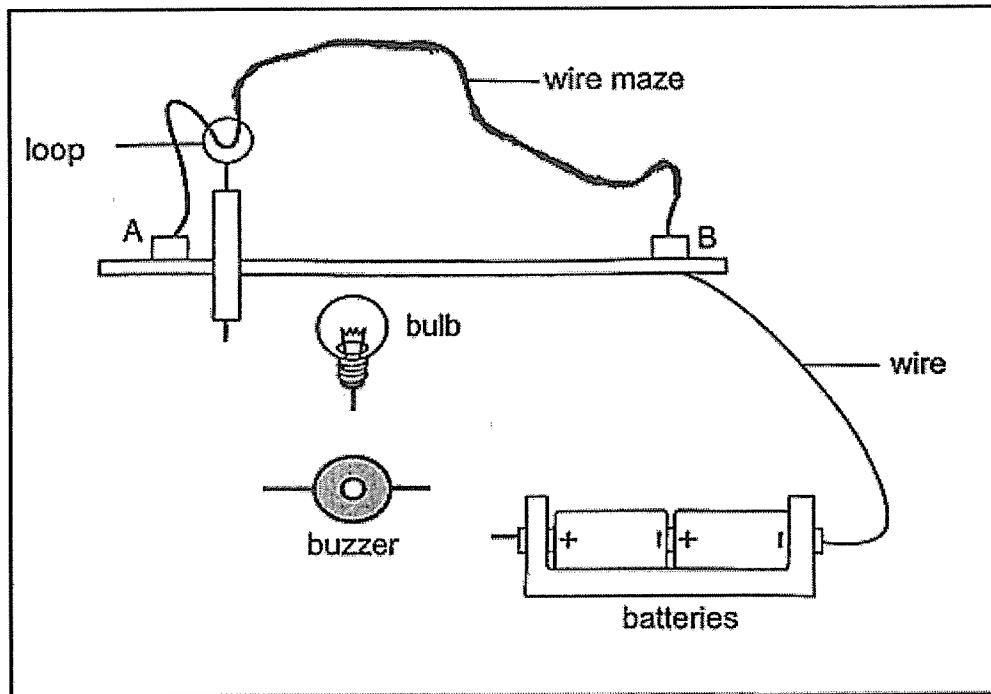

(b) Suggest the property of material of the wire maze and the loop. [1]

(c) Predict how the brightness of the bulb will change if more batteries are connected. [1]

- 36 Timothy took part in a game show. To answer the questions, the contestants had to press the button in front of them to ring the buzzer. Only one of the contestants buzzer would ring at a time.

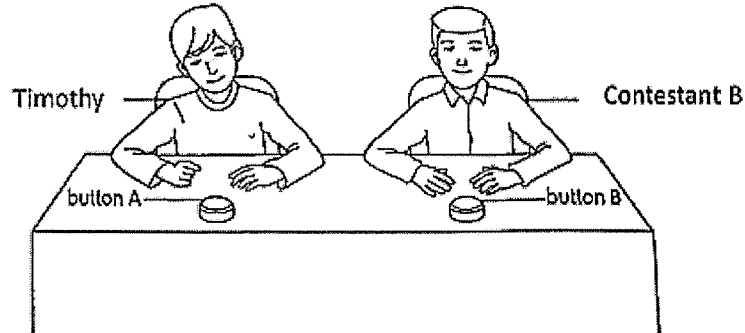

The diagram below showed the electrical circuit that allowed the buzzer to ring. Iron bars, A and B, could move about their fixed points.

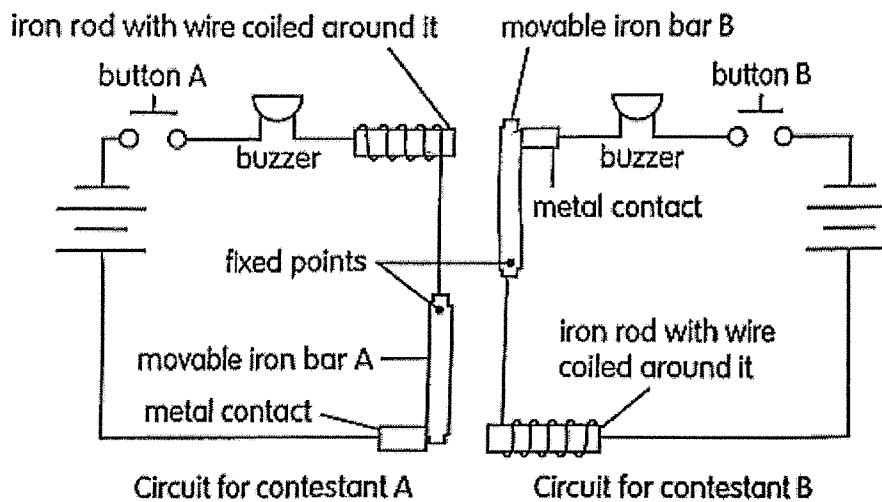

- (a) Explain how the above electrical circuit works. [2]

Q36 is continued on the next page

Timothy won a prize in the game show. He received three electrical lanterns which he placed at different locations in his house as shown below.

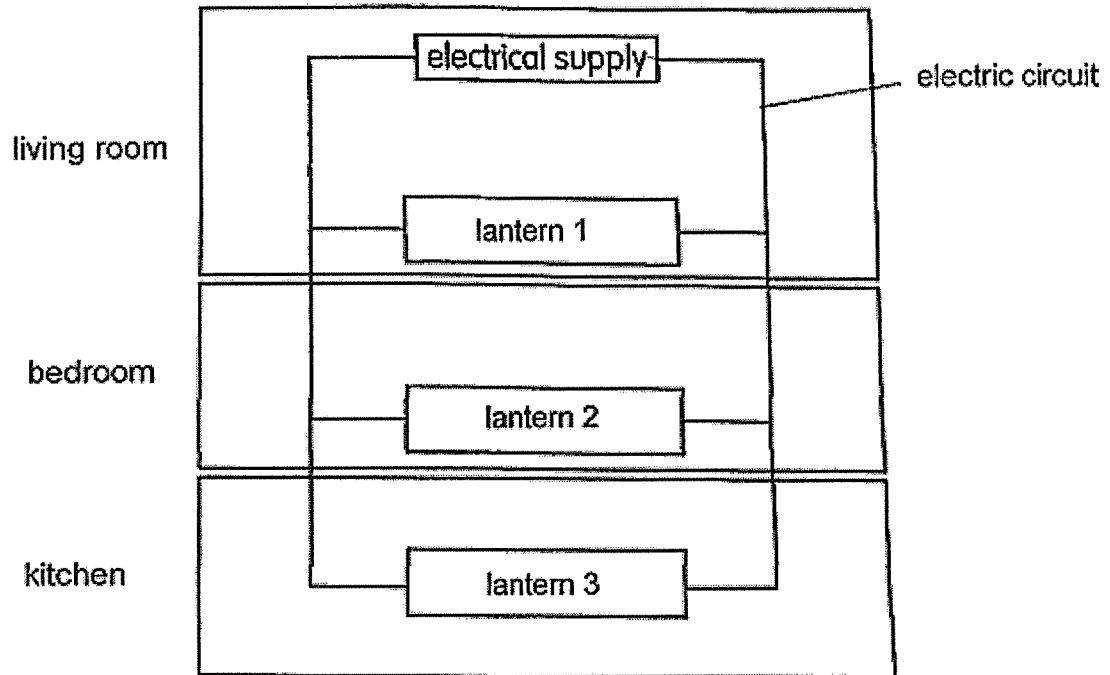

Timothy wanted to include switches to control the lanterns in the following manner:

- All the lanterns can be controlled by a main switch
- The lanterns in the bedroom and kitchen can be controlled independently.

(b) On the diagram above, draw an 'X' to indicate where each of the three switches should be placed. [3]

- 37 Darren boiled some water using an electric kettle. The following graph shows the change in temperature of water in the kettle.

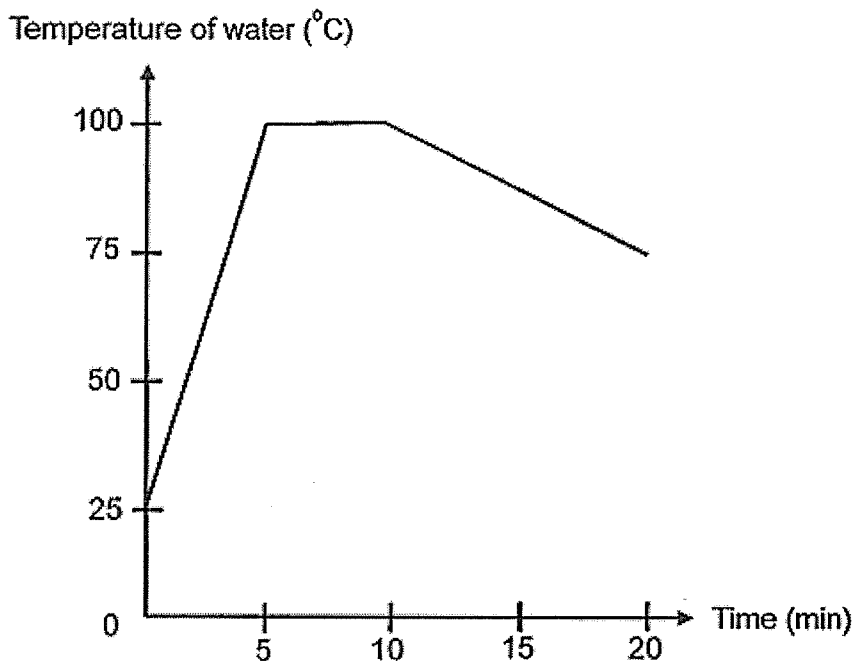

- (a) State the relationship of the change in temperature of water in the kettle from the start of the experiment until 10min. [1]

- (b) List the state(s) of water present between the 5th and 10th minute. [1]

- (c) Define boiling point. [1]

- 38 Jeremy carried out an experiment to find out how the exposed surface area of a liquid affects the rate of freezing. He poured equal volumes of liquids into containers, X, Y and Z, as shown below. Then, he placed the containers in a freezer.

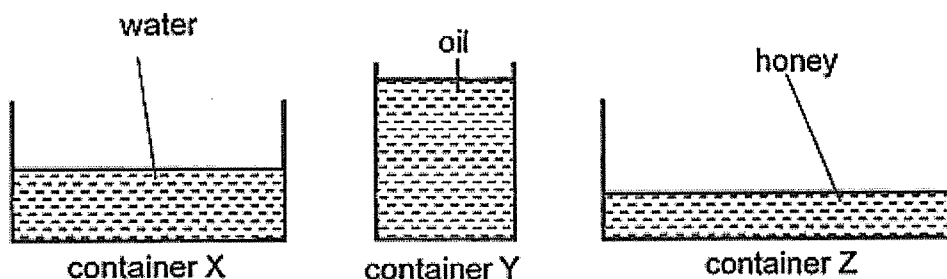

- (a) Explain why Jeremy's experiment was not a fair one. [2]

Jeremy repeated his experiment after making some changes so that his experiment was fair. He recorded the time taken for the liquid in each container to freeze completely in the table below.

Container	Time taken for the liquid to freeze (min)
X	40
Y	60
Z	20

- (b) Suggest one way to reduce the time needed to freeze the liquid in all the containers. [1]

39 Ron created a model of a water cycle as shown below.

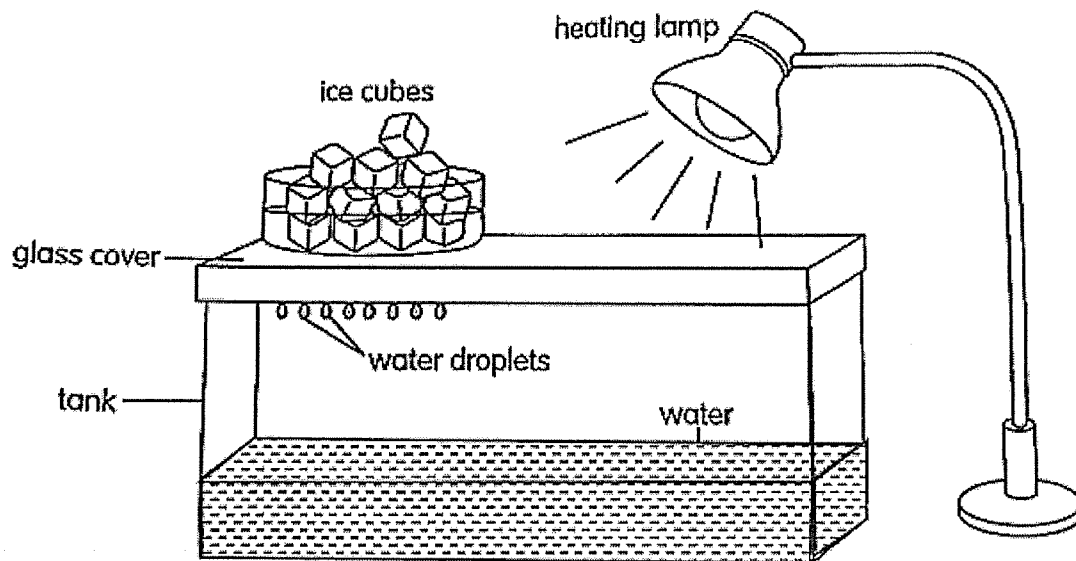

(a) Explain why ice cubes were placed above the glass cover.

[2]

(b) What did the following objects represent in the water cycle?

[1]

(i) Heating lamp: _____

(ii) Water droplets on the glass cover: _____

- 40 Megan carried out an investigation of two containers of different materials, A and B, as shown below. He placed a beaker of water into the containers and took some readings.

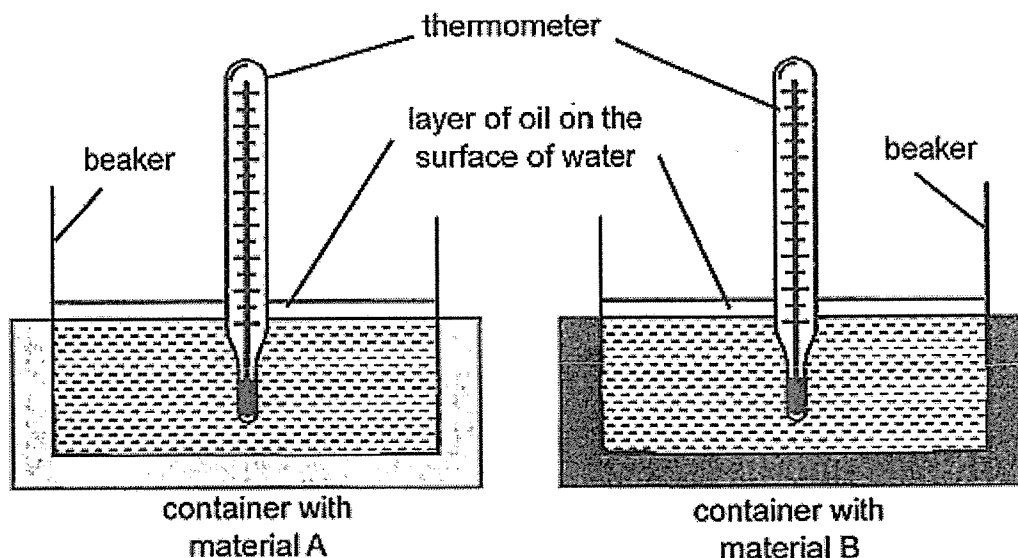

- (a) Based on Megan's experiment, tick (✓) the correct variables accordingly in the table below. [2]

	Variable	Changed	Kept the Same	Measured
(i)	Thickness of material of container			
(ii)	Temperature of water in container			
(iii)	Volume of water in container			
(iv)	Type of material for container			

- (b) Megan set-up a control set-up for her investigation. What is the purpose of the control set-up? [1]

Q40 is continued on the next page

(c) In the space below, draw the control set-up with labels.

The thermometer is drawn for you

[1]

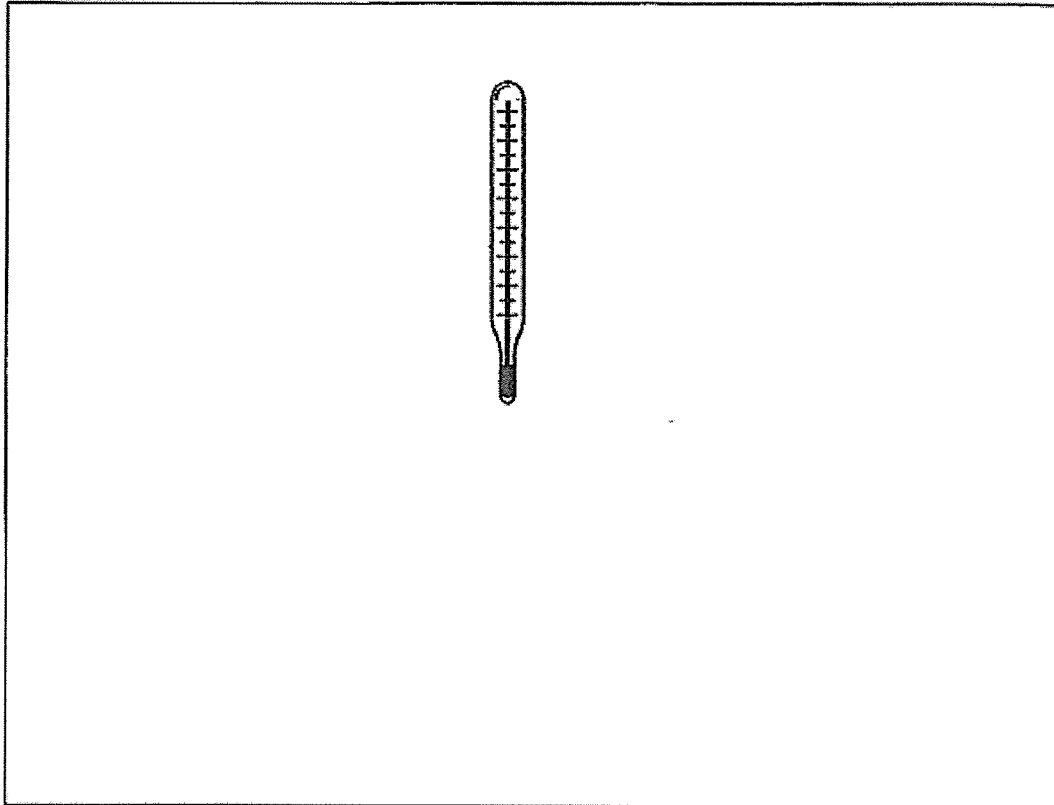

The End

[Faint, illegible text at the bottom of the page, possibly bleed-through from the reverse side.]

SCHOOL : ROSYTH SCHOOL
LEVEL : PRIMARY 5
SUBJECT : SCIENCE
TERM : SA2

SECTION A

Q 1	Q2	Q3	Q4	Q5	Q6	Q7	Q8	Q9	Q10
2	4	2	4	3	4	2	2	1	2
Q 11	Q12	Q13	Q14	Q15	Q16	Q17	Q18	Q19	Q20
2	4	4	2	4	1	1	3	3	3
Q 21	Q22	Q23	Q24	Q25	Q26	Q27	Q28		
2	4	2	4	2	2	4	4		

SECTION B

Q29a)	FALSE, FALSE, TRUE, TRUE
Q29b)	No, as we grow taller, our cells undergo cell division to multiply instead of growing bigger in size.
Q30a)	Leaves Y: it would wither. Leaves Z: Leaves Z would still be able to photosynthesise and remain healthy.
Q30b)	The food made by the leaves through photosynthesis cannot be transported down the stem, hence, excess food made is stored in the fruit, producing bigger fruit.
Q31a)	Food
Q31b)	Leaves will use water to make food through photosynthesis.
Q31c)	Water absorbed by plant roots is transported from roots to stem to leaves, and will not return to the roots. While blood is pumped by the heart and transported in humans which would return to the heart.
Q32a)	Pollen grains will be transferred from the anther to the stigma of the same type of flower.
Q32b)	

Q32c)	The change in colour would attract more animals to eat the fruit, and increase chances of its seeds being passed out in droppings further away from the parent. Hence, this increases chances of seed dispersal.
Q33a)	As light intensity decreases, the number of fully submerged green plants decreases.
Q33b)	As depth of pond increases, less light is able to reach fully submerged green plants, so plant are less able to carry out photosynthesis to make food, which is needed for survival.
Q34a)	Set-up P: oxygen increased , carbon dioxide decreased Set-up Q: no change for both
Q34b)	Kenny was trying to find out how the presence of leaves affect the amount of oxygen and carbon dioxide in the set-ups.
Q34c)	To ensure a fair test by keeping all variables constant except for one.
Q34d)	Yes. Photosynthesis would be unable to take place due to absence of light, hence, plant would only be able to respire, decreasing amount of oxygen and increasing carbon dioxide levels.
Q35a)	
Q35b)	Ability to conduct electricity.
Q35c)	Brightness of bulb would increase.
Q36a)	If button A is pressed, it would close the gap in the circuit, making it complete. The iron rod will become an electromagnet, attracting movable iron bar B, creating 2 gaps in circuit B. Hence even if contestant B presses button B, the circuit is still open and buzzer would not ring.
Q36b)	
Q37a)	minute to 10th minute, temperature remains constant at 100°C.

ase. From 5th

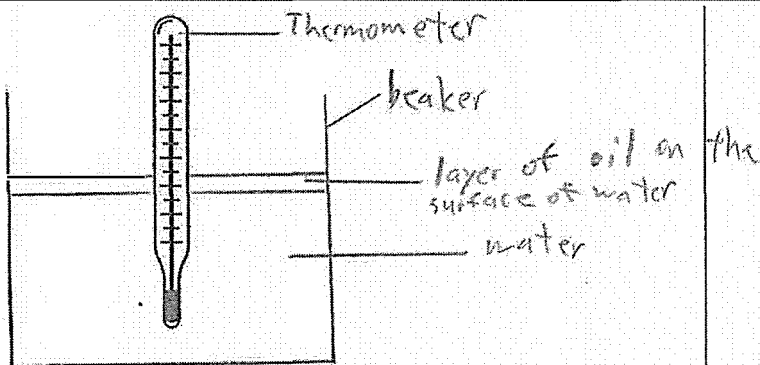
Q37b)	Liquid and gas
Q37c)	It is the temperature at which a liquid gains heat to become gas at a fixed temperature.
Q38a)	It is not a fair experiment as there is more than one variable that is changed, which are the types of liquids and exposed surface area of each container. In a fair experiment, only one variable is changed while all others are kept constant.
Q38b)	Use liquids which are cooler in temperature.
Q39a)	When water in tank gains heat and evaporates into water vapour, the water vapour would touch the cooler underside of the glass cover, which is cooler than room temperature due to the ice cubes. Water vapour would then lose heat and condense to form water droplets under the glass cover.
Q39b)	(I) The Sun (II) Clouds
Q40a)	(I) Kept the same (II) Measured (III) Kept the same (IV) Changed
Q40b)	The purpose is to ensure that the temperature of water in the container is affected only by the type of material for container and not by any other variables in the experiment.
Q40c)	 <p>The diagram shows a rectangular beaker. Inside the beaker, there is a layer of oil on top of a layer of water. A thermometer is placed vertically in the water. Handwritten labels with lines pointing to the corresponding parts are: 'Thermometer' pointing to the thermometer, 'beaker' pointing to the container, 'layer of oil on the surface of water' pointing to the top layer, and 'water' pointing to the bottom layer.</p>

