



NAN HUA PRIMARY SCHOOL
END-OF-YEAR EXAMINATION 2025
PRIMARY 4

SCIENCE
(BOOKLET A)

Total Time for Booklets A and B: 1 hour 45 minutes

INSTRUCTIONS TO CANDIDATES

1. Write your name, index number and class in the spaces provided below.
2. Do not turn over the page until you are told to do so.
3. Follow all instructions carefully.
4. Answer all questions.
5. Use a 2B pencil to shade your answers on the Optical Answer Sheet (OAS).

Marks Obtained

Booklet A		/ 60
Booklet B		/ 40
Total		/ 100

Name: _____ ()

Form Class: P4 _____

Teaching Group: 4S _____

Date: 28 October 2025

Parent's Signature: _____

This booklet consists of 20 printed pages.

For each question from 1 to 30, four options are given. One of them is the correct answer. Mark your choice (1, 2, 3 or 4) and shade your answer on the Optical Answer Sheet. (60 marks)

1 Which one of the following is a living thing?

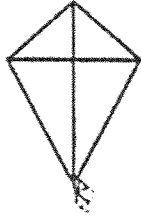

(1)



(2)

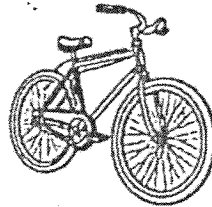

(3)

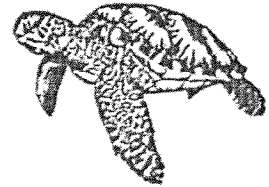

(4)

2 The diagram shows the life cycle of a plant.

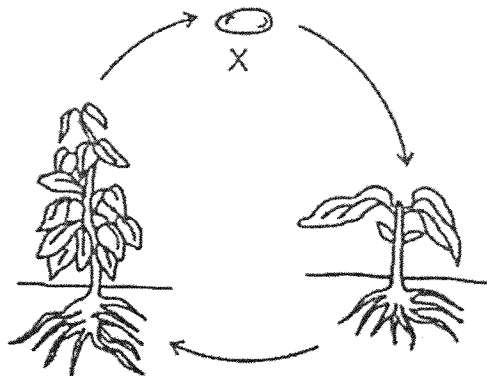

What is the stage marked X?

- (1) egg
 - (2) seed
 - (3) adult plant
 - (4) young plant
- 3 Which animal has pupa as a stage in its life cycle?
- (1) chicken
 - (2) cockroach
 - (3) grasshopper
 - (4) mealworm beetle

4 Which of the following is a correct function of the root?

- (1) keeps the plant upright
- (2) takes in air for the plant
- (3) makes food for the plant
- (4) holds the plant firmly to the soil

5 Which human system is shown in the diagram?

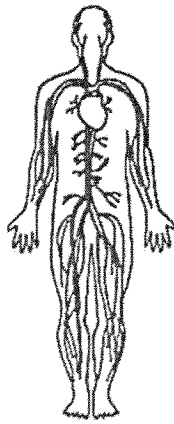

- (1) skeletal system
- (2) muscular system
- (3) circulatory system
- (4) respiratory system

6 Matter is anything that has mass and occupies space.

Which of the following is not matter?

- (1) balloon
- (2) light
- (3) wind
- (4) soil

(Go on to the next page)

- 7 The diagram shows a hammer.

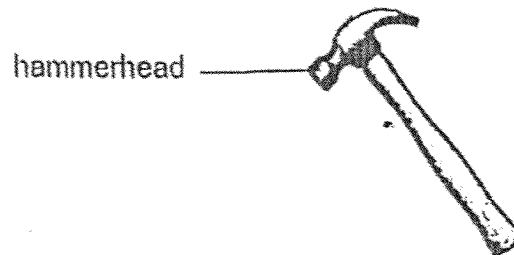

Metal is used to make the hammerhead of the hammer because metal _____

- (1) can absorb water
 - (2) does not break easily
 - (3) can bend without breaking
 - (4) does not allow light to pass through
- 8 The diagram shows a magnet held above a plastic object.

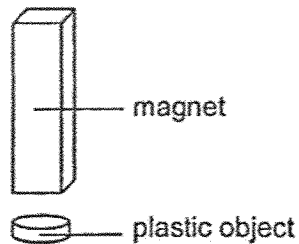

What will happen to the plastic object?

- (1) It will move up.
- (2) It will not move.
- (3) It will move to the left.
- (4) It will move to the right.

9 Which of the following is a source of light?

(1)



an eye

(2)



a leaf

(3)



a fire

(4)



a mirror

10 Katie wants to measure the temperature of the water in a container.

Which of the following diagrams shows the correct position of the thermometer when taking the temperature reading?

(1)

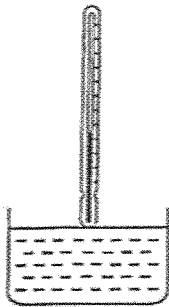

(2)

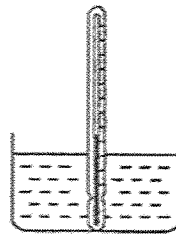

(3)

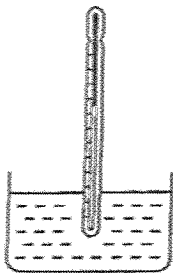

(4)

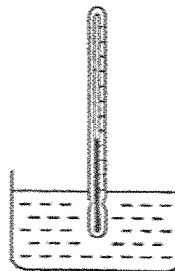

(Go on to the next page)

- 11 Emma planted a seed and measured its growth in height over four weeks. The height of the plant at the end of each week is recorded. The results are as shown.

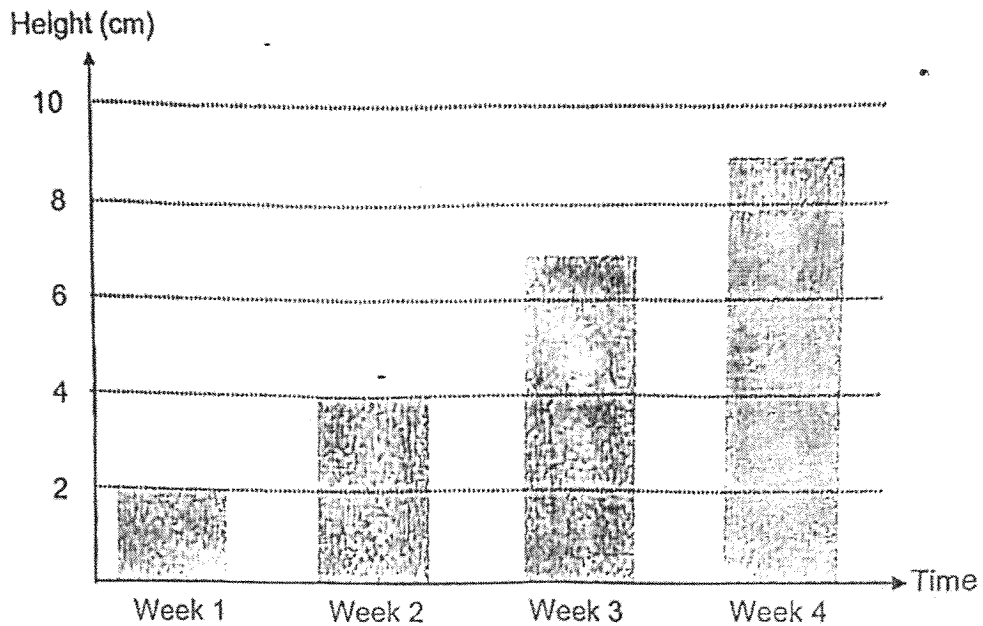

Based on the results, she made the following statements.

- A The plant can grow.
- B The plant can reproduce.
- C The plant need air to survive.
- D The number of plants increased by two in Week 2.

Which statement(s) is/are correct?

- (1) A only
- (2) A and C only
- (3) B and D only
- (4) A, B, C and D

12 Raju recorded some information on two plants, X and Y, in the table below.

Type of plant	Characteristics	
	Does it produce fruits?	Is it a water plant?
X	No	Yes
Y	Yes	No

Based on the information from the table, he drew a flow chart as shown below.

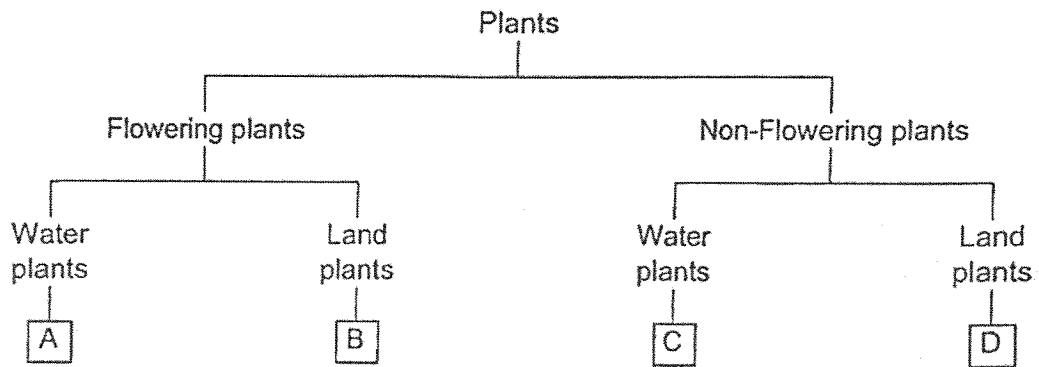

Where would Raju place plants X and Y in the flow chart?

	Plant X	Plant Y
(1)	A	D
(2)	B	C
(3)	C	B
(4)	D	A

(Go on to the next page)

- 13 The table below shows what a student had observed about the growth of insect A.

Date	Observation
1 September	Eggs were laid.
2 September	Eggs hatched to become larvae.
7 September	Some larvae develop into pupae.
9 September	Some pupae become adult insects.

Based on the information above, which statement is correct?

- (1) Adult insect A gives birth to young alive.
 - (2) The larva has three body parts and a pair of wings.
 - (3) Insect A spends more time as a larva than as a pupa.
 - (4) The chicken has the same number of stages in its life cycle as insect A.
- 14 Which statement(s) about the human digestive system is/are correct?

- A Digestion takes place in the mouth and stomach.
- B Food is fully digested and absorbed into bloodstream in the stomach.
- C Digestion refers to food being broken down into smaller pieces and absorbed into the bloodstream.

- (1) A only
- (2) A and C only
- (3) B and C only
- (4) A, B and C

15 Jane went cycling on a bicycle.

Which of her human body system(s) was/were working as she cycled?

- A circulatory system
- B muscular system
- C respiratory system
- D skeletal system

- (1) B only
- (2) D only
- (3) A, C and D only
- (4) A, B, C and D

16 M, N, P and Q are the same type of flowering plant. N, P and Q have different parts removed as stated in the table. No plant parts were removed from plant M. The four plants were left to grow for a week, and the following observations were recorded.

Plant	Part removed	Observation after one week
M	none	The plant grew taller and produced fruits.
N	roots	The leaves of the plants dried up.
P	leaves	The plant died.
Q	flowers	The plant grew taller and did not have fruits.



Which of the statements explains the observations of the four plants?

- A Without flowers, the plant cannot produce fruits.
- B Without leaves, the plant cannot make food to stay alive.
- C Without roots, the plant cannot stay firmly to the ground.

- (1) A only
- (2) A and B only
- (3) B and C only
- (4) A, B and C

(Go on to the next page)

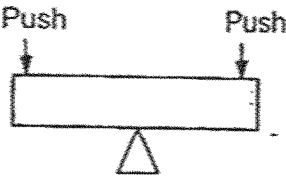
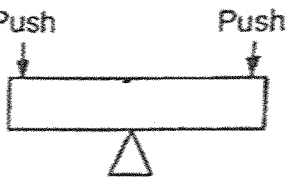
- 17 Malan wanted to find out the property of two materials. He prepared two bars, K and L, made of different materials. He tried to bend the two bars by pushing down the two ends of each bar and the results are as shown below.

	Bar K	Bar L
Start of the experiment		
End of the experiment		

Which statement can be concluded from the results of the experiment?

- (1) K is more flexible than L.
- (2) L is more flexible than K.
- (3) K is stronger than L.
- (4) L is stronger than K.

18 The diagram shows an umbrella used on a rainy day.

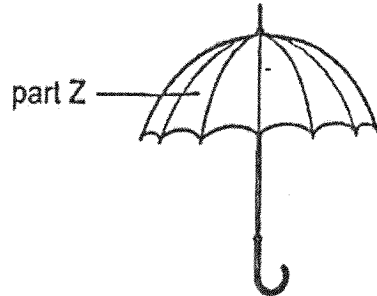

Which material is the most suitable for making part Z of the umbrella?

	Material	Property		
		strong	flexible	waterproof
(1)	P	x	✓	x
(2)	Q	✓	x	✓
(3)	R	✓	✓	x
(4)	S	✓	✓	✓

Key

✓ : Yes

x : No

(Go on to the next page)

19 Kenny wanted to use a magnet to tell direction.

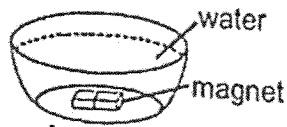

A

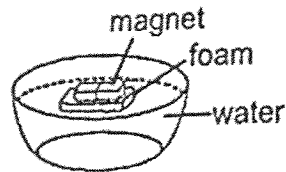

B

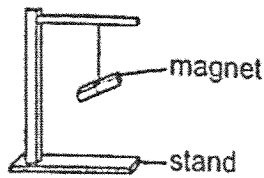

C

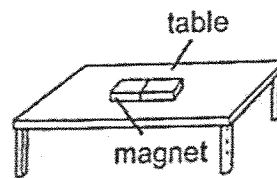

D

Which set-ups would allow Kenny to do so?

- (1) A and B only
- (2) A and D only
- (3) B and C only
- (4) C and D only

20 Alan stacked four rings as shown below. Two of the rings are magnets while the other two are made of non-magnetic materials.

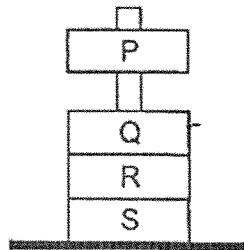

Which rings are magnets?

- (1) P and Q
- (2) P and S
- (3) Q and R
- (4) R and S

21 The diagram below shows three set-ups used to make magnets from iron rods.

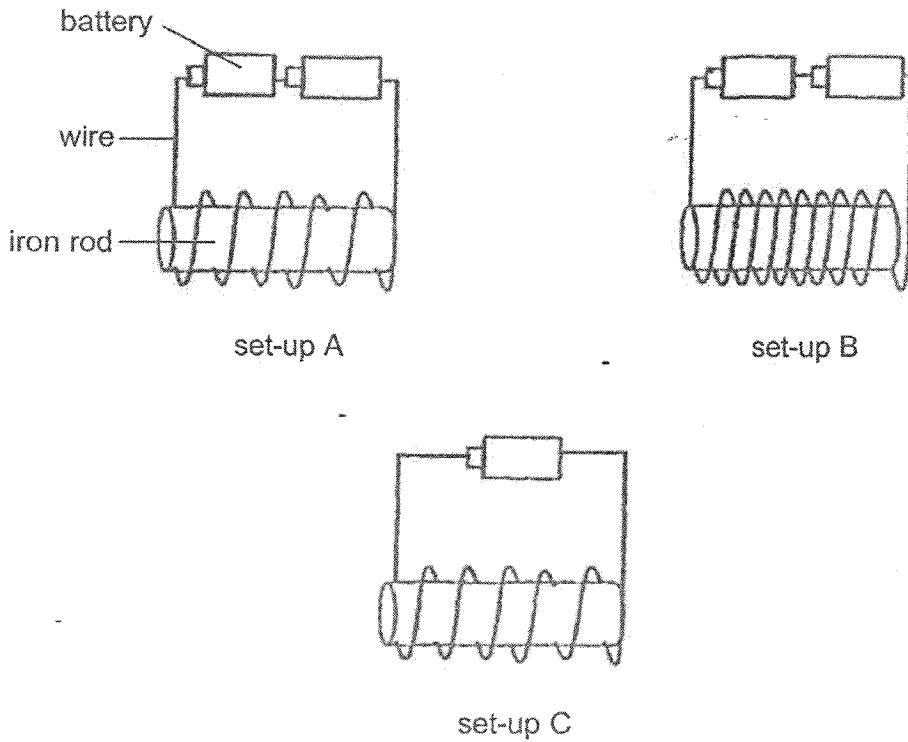

Which row shows the likely number of iron thumbtacks that would be attracted to the magnets in each set-up?

	Set-up A	Set-up B	Set-up C
(1)	3	6	3
(2)	6	10	3
(3)	10	6	10
(4)	10	10	6

(Go on to the next page)

22 Jenny has two similar sealed containers, X and Y, with a volume of 200 cm^3 each.

She pumped 300 cm^3 of air into container X and 200 cm^3 of air into container Y.

Which of the following shows the correct observation after the air is pumped into the containers?

(1)

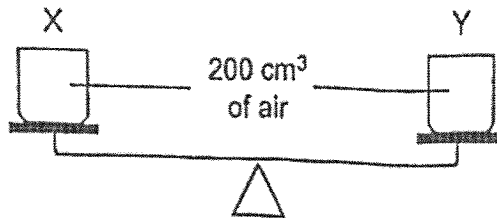

(2)

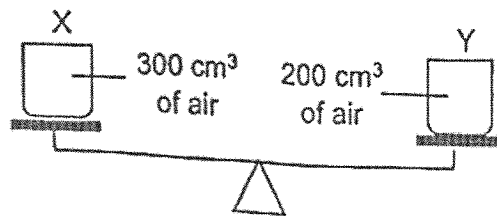

(3)

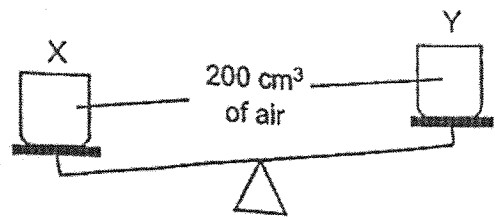

(4)

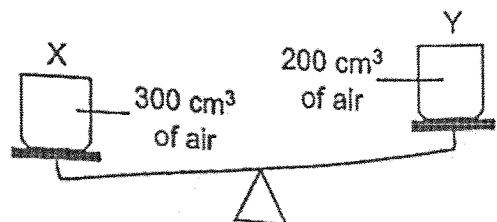

- 23 The table below shows the properties of three substances, E, F, and G.

Properties	Substances		
	E	F	G
Has definite shape	x	✓	x
Has definite volume	✓	✓	x
Can be compressed	x	x	✓

Key

✓ : Yes

x : No

Which of the following best represents E, F and G?

	E	F	G
(1)	air	wood	oil
(2)	oil	sand	air
(3)	sand	wood	air
(4)	oil	air	sand

- 24 Kelly set up an experiment using four solid objects. Objects in set-up A, B and C are made of metal. Object in set-up D is made of wood.

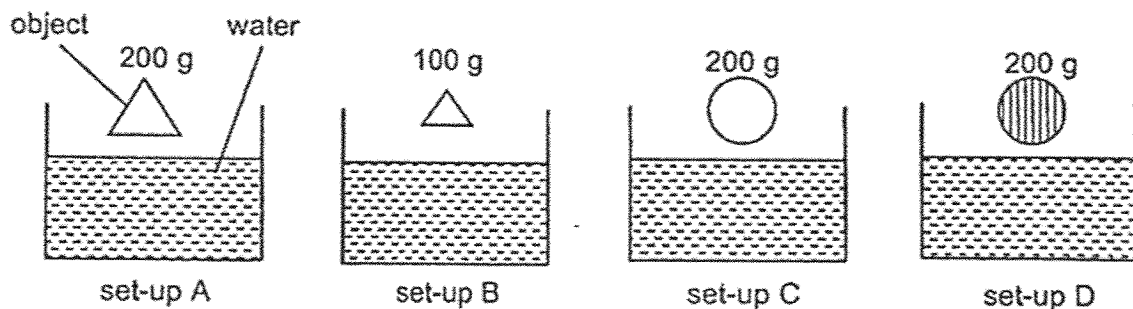

She wanted to find out if the shape of objects affects the time taken for them to sink to the bottom of the tanks.

Which pair of set-ups should she use?

- (1) A and B
- (2) A and C
- (3) A and D
- (4) C and D

(Go on to the next page)

25 Which diagram shows the shadow of the tree correctly?

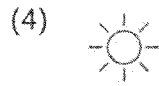
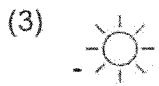
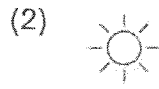
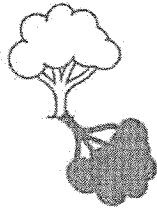
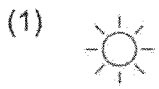

26 A ball was placed between a translucent paper and a screen.

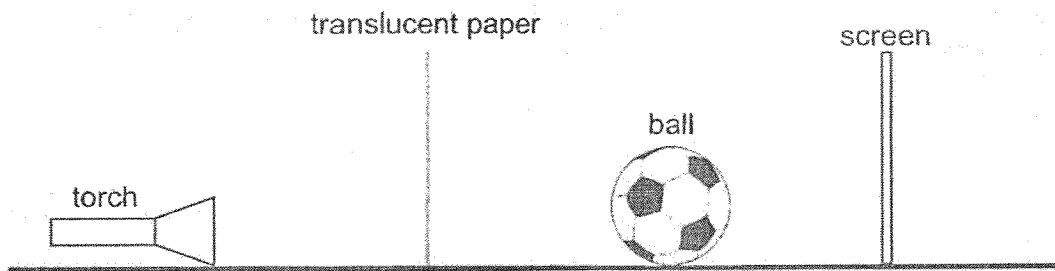

Which shadow will be seen on the screen when the torch is switched on?

(1)

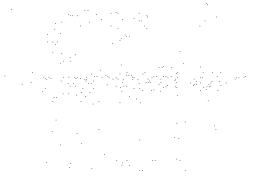

(2)

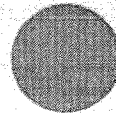

(3)

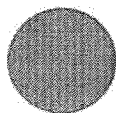

(4)

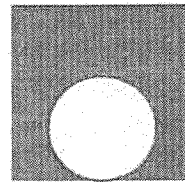

27 The diagram shows three objects of the same height.

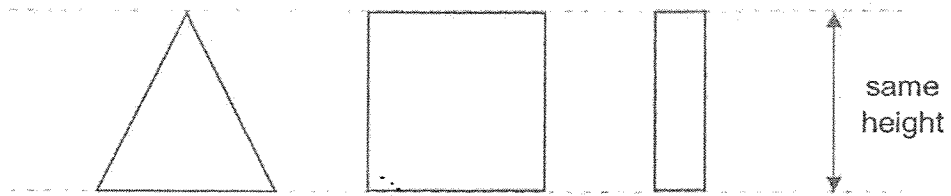

The three objects are placed at different positions between a light source and a screen.

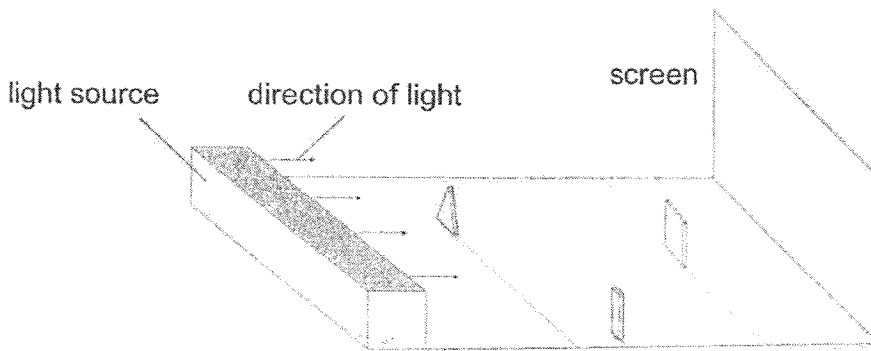

Which of the following shows the shadows formed on the screen?

(1)

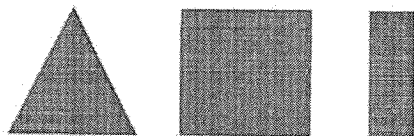

(2)

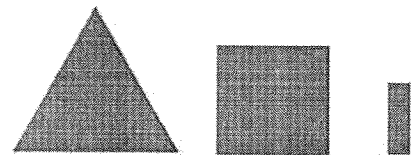

(3)

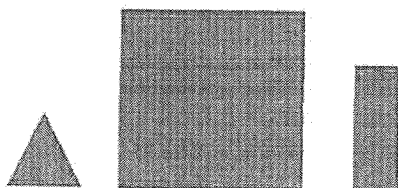

(4)

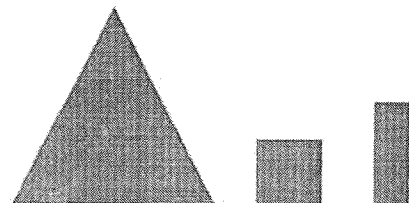

(Go on to the next page)

- 28 Jack placed a metal spoon into a cup of cold juice. When he touched the spoon, the spoon felt cold.

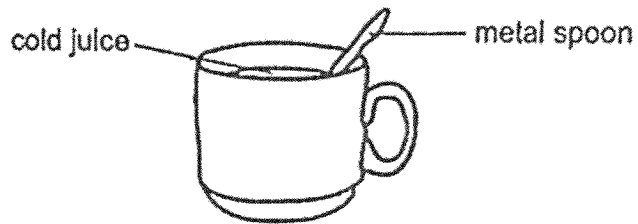

Which statement(s) correctly explain(s) Jack's observation?

- A Jack's hand gained coldness from the spoon.
 - B Jack's hand lost heat to the spoon.
 - C The spoon gained heat from Jack's hand.
 - D The spoon lost heat to Jack's hand.
- (1) A only
(2) D only
(3) B and C only
(4) B and D only

29 Michelle heated a pot of soup over the stove as shown in the diagram.

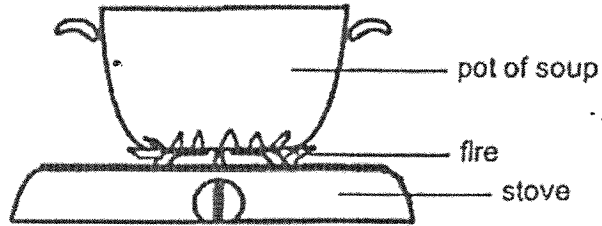

After heating for 5 minutes, she turned off the fire and placed the pot of soup on the kitchen table. 10 minutes later, she placed the pot of soup over the stove and turned on the fire to continue heating the soup again for another 15 minutes.

Which graph shows how the temperature of the pot of soup changed with time?

(1) Temperature ($^{\circ}\text{C}$)

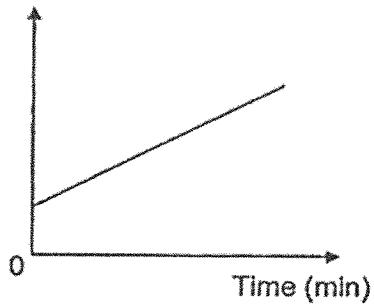

(2) Temperature ($^{\circ}\text{C}$)

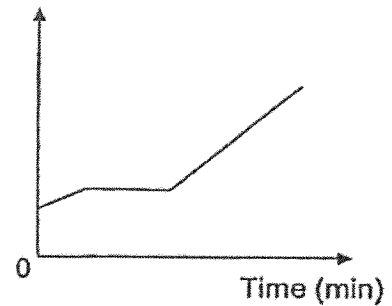

(3) Temperature ($^{\circ}\text{C}$)

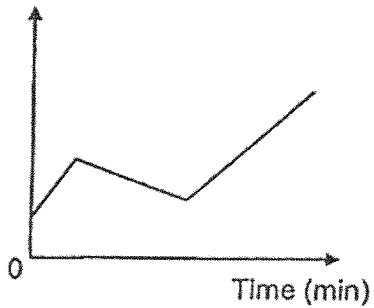

(4) Temperature ($^{\circ}\text{C}$)

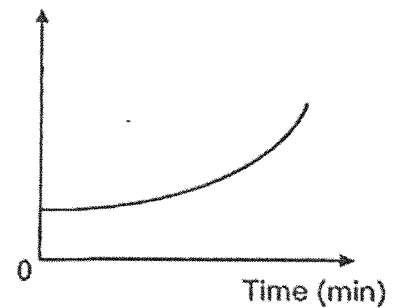

(Go on to the next page)

30 Adam carried out an experiment with two set-ups, J and K, as shown in the diagram.

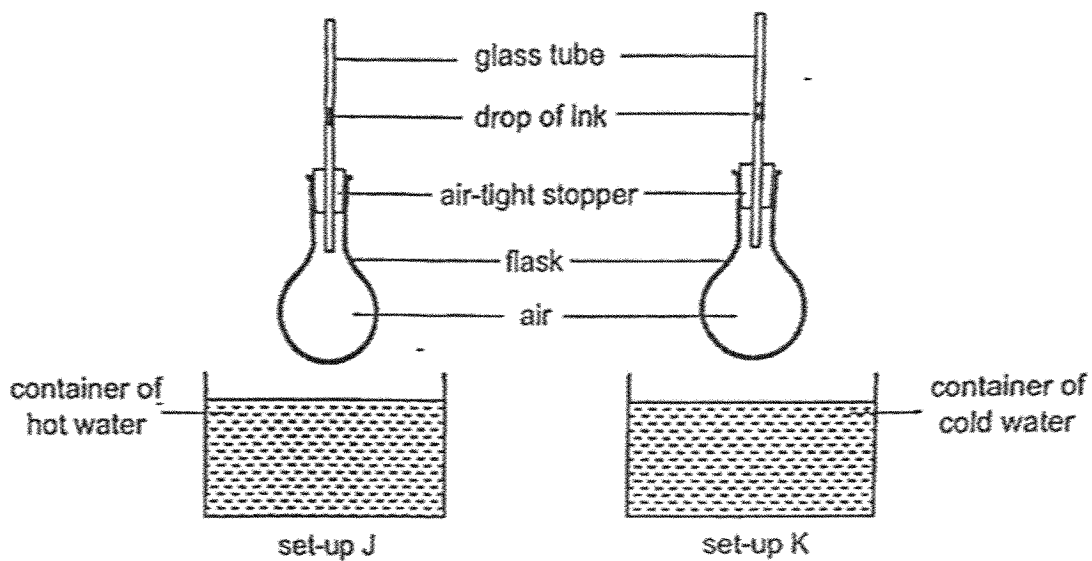

Which row correctly describes the movement of the drop of ink two minutes after each flask was placed into the respective containers of water?

Movement of ink		
	set-up J	set-up K
(1)	falls	falls
(2)	falls	rises
(3)	rises	falls
(4)	rises	rises

(Go on to Booklet B)



NAN HUA PRIMARY SCHOOL
END-OF-YEAR EXAMINATION 2025
PRIMARY 4

SCIENCE
(BOOKLET B)

Total Time for Booklets A and B: 1 hour 45 minutes

INSTRUCTIONS TO CANDIDATES

1. Write your name, index number and class in the spaces provided below.
2. Do not turn over the page until you are told to do so.
3. Follow all instructions carefully.
4. Answer all questions.
5. Use dark blue or black ballpoint pen to write your answers in the space provided for each question.
6. Do not use correction fluid/tape or highlighter.

Marks Obtained

Booklet B

	/ 40
--	------

Name: _____ ()

Form Class: P4 _____

Teaching Group: 4S _____

Date: 28 October 2025

Parent's Signature: _____

This booklet consists of 14 printed pages.

For questions 31 to 43, write your answers in this booklet.

The number of marks available is shown in brackets [] at the end of each question or part question. (40 marks)

31 Identify the outer covering of each animal group by choosing the words from the box. [2]

moist skin	scale	hair	feather
------------	-------	------	---------

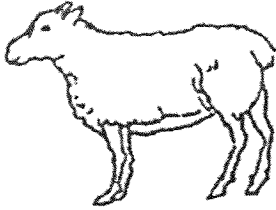
	Animal Group	Outer covering
(a)	 Amphibian	
(b)	 mammal	

Score	2
-------	---

32 A magnet is used to put up a paper on the board.

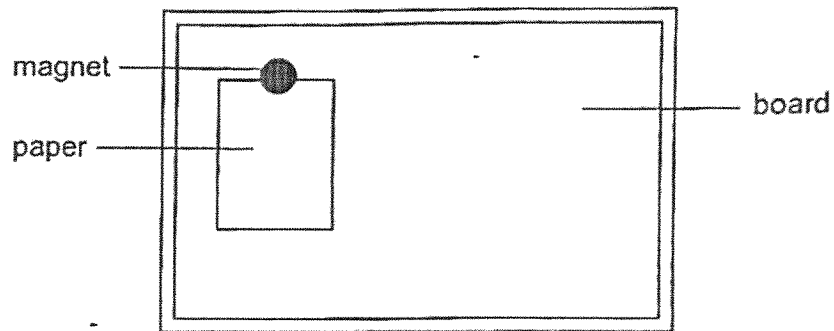

(a) Circle the correct answer.

A material that can be used to make the board is (*glass / rubber / steel*). [1]

(b) The paper will not drop from the board because the magnet _____ the board. [1]

33 The picture below shows a bucket of paint.

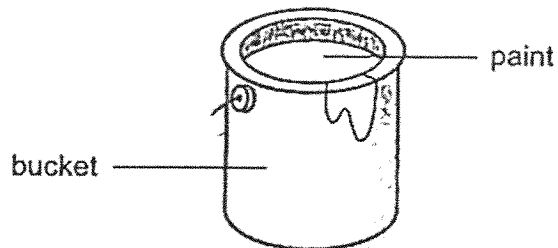

Circle the correct state for the following things.

(a) bucket: *solid / liquid / gas* [1]

(b) paint: *solid / liquid / gas* [1]

Score	4
-------	---

(Go on to the next page)

34 The diagram below shows how Jack sees the teddy bear.

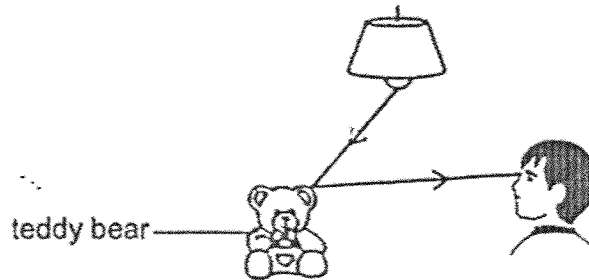

- (a) The _____ from the lamp is _____ by the teddy bear and enters Jack's eye. [2]

Jack tilts his head upwards to look at the lamp.

- (b) Explain why Jack can see the lamp. [1]

35 The diagram shows a bottle of water.



Fill in the blanks using the correct words in the box.

gas	decreases	solid
remains unchanged	increases	

- (a) When the water loses heat, its temperature _____. [1]
- (b) The bottle of water is put in the freezer. After some time, the water will change its state to _____. [1]

Score	5
-------	---

36 Donald built a small pond in a garden on Day 1.

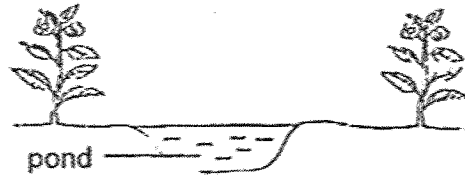

Donald observed two types of animals, butterfly and frog, living in the garden. The number of days needed for their eggs to hatch is shown below.

Characteristic	butterfly	frog
Number of days needed for eggs to hatch	3	21

(a) On Day 14, what would Donald most likely find in the pond? Put a '✓' in the correct box(es). [1]

- tadpoles
 frog eggs
 butterfly larvae
 butterfly pupae

(b) The diagram below shows the life cycles of a frog and a mosquito.



life cycle of a frog

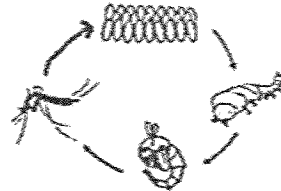

life cycle of a mosquito

(i) State one similarity and one difference between the life cycles of a frog and a mosquito. [2]

Similarity: _____

Difference: _____

(ii) State another animal that has the same number of stages in its life cycle as a frog. [1]

Score	4
-------	---

- 37 Lynette wanted to investigate how the size of food affects the time it takes to be digested. She set up three test tubes P, Q and R, each containing 5 g of food cut into different sizes. In each test tube, she added 10 ml of digestive juices.

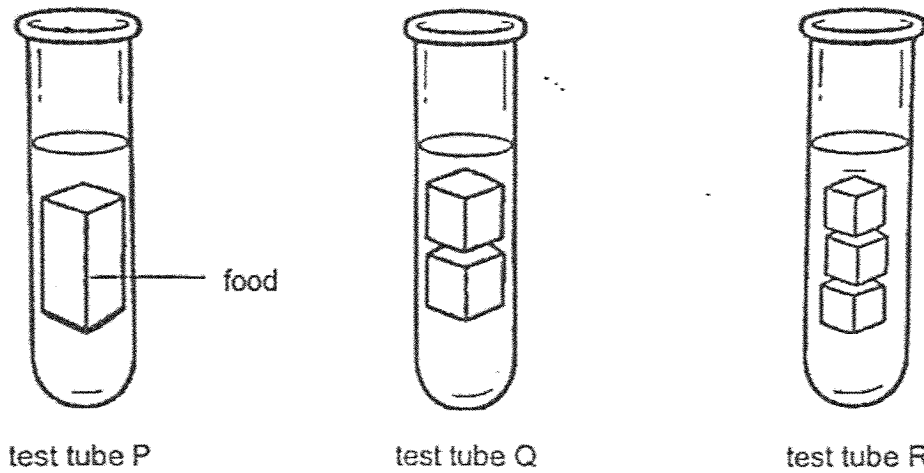

At the end of one hour, Lynette recorded the mass of the food left in each test tube.

Test Tube	Mass of the food left after one hour (g)
P	3
Q	2
R	1

- (a) What is the relationship between the size of the food and mass of food left after one hour in each test tube? [1]

- (b) Explain your answer in (a). [2]

(c) The diagram below shows the human digestive system.

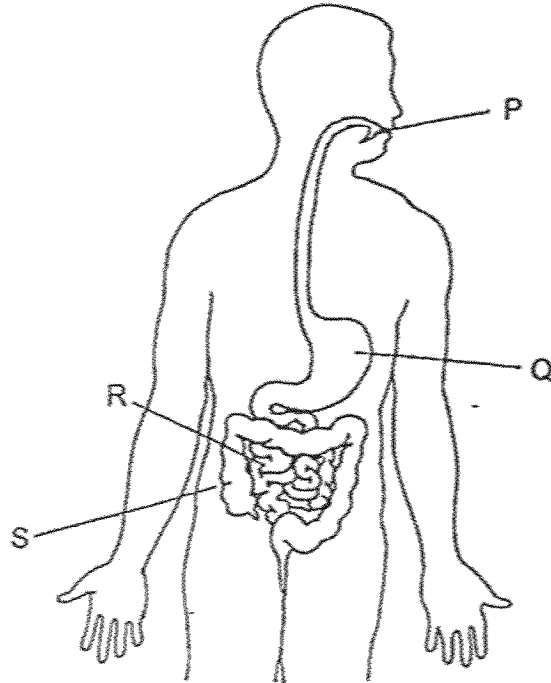

Which part(s), P, Q, R and/or S absorbs water from the undigested food?

[1]

Score	4
-------	---

(Go on to the next page)

38 The diagram below shows the growth of plant Z over a period of two weeks.

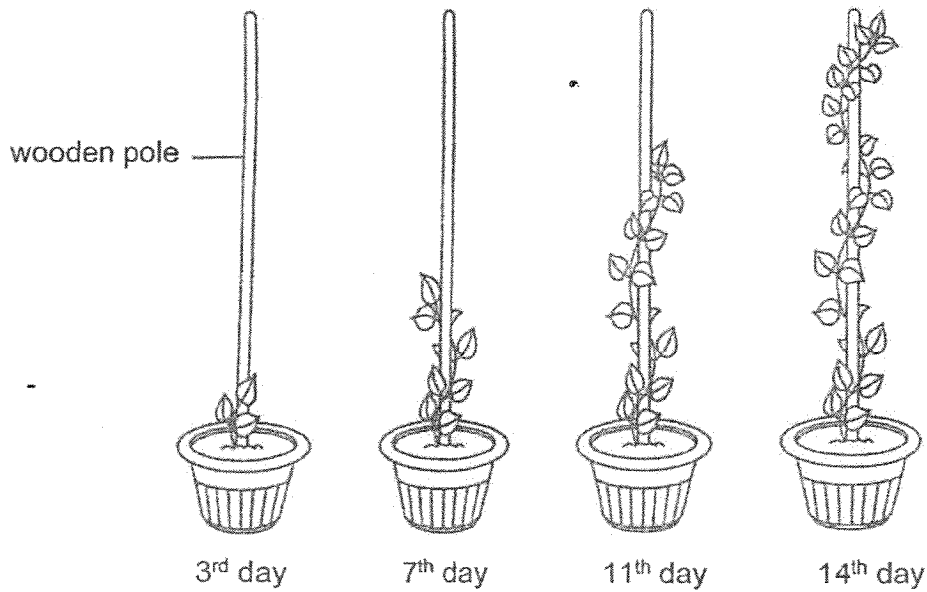

(a) Why does the plant need to climb up the wooden pole as it grows? [1]

(b) Based on the diagram above, put a tick (✓) in the correct boxes to indicate whether the statements about plant Z are 'True', 'False' or 'Not possible to tell'. [3]

	Statements	True	False	Not possible to tell
(i)	Plant Z has a non-woody stem.			
(ii)	Leaves of plant Z cannot make food without the wooden pole.			
(iii)	Plant Z will grow flowers after another two weeks.			

Score	4
-------	---

- 39 Halimah wanted to choose a suitable material for making a swimming board that would help her when she swims.

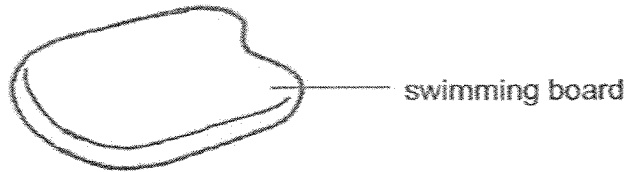

She placed four blocks A, B, C and D of the same size in a container of water. The diagrams below show what she observed after one minute.

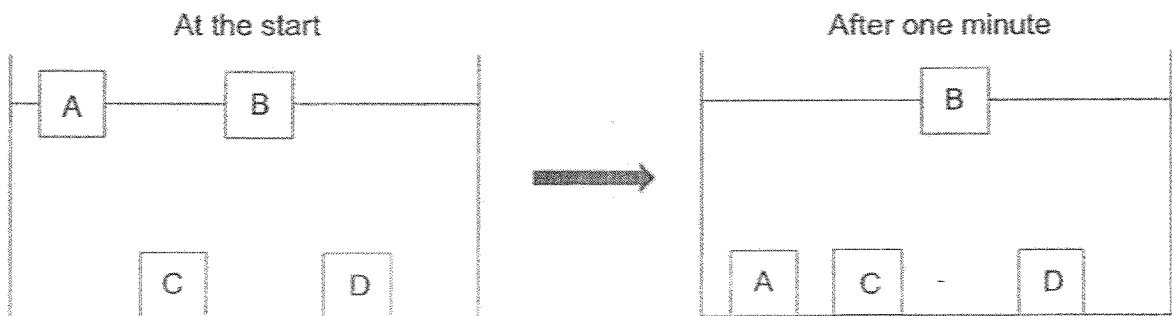

- (a) Halimah concluded that blocks C and D must be made of the same material. Do you agree? Give a reason for your answer. [1]
- (b) Which block, A, B, C or D, is made of a material that is suitable for making the swimming board? Explain your answer. [1]
- (c) Give a reason for the observation of block A after one minute. [1]

Score	3
-------	---

(Go on to the next page)

40 Sarah conducted an experiment using the set-up below.

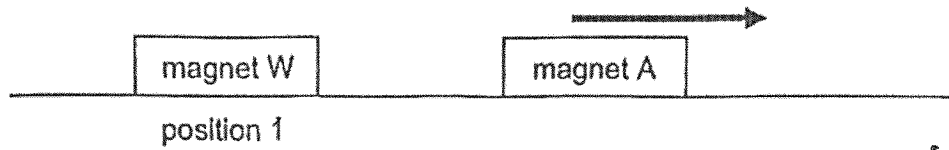

When magnet W was placed at position 1, magnet A moved to the right as shown by the arrow.

(a) Explain why magnet A moved to the right when magnet W was placed at position 1. [1]

Sarah repeated the experiment with magnets X, Y and Z, and recorded the distance moved by magnet A to the right in the table below.

Magnet	Distance moved by magnet A (cm)
W	2
X	0
Y	8
Z	5

(b) Based on the results, arrange the magnets, W, X, Y and Z, from the strongest magnetic strength to the weakest. [1]

strongest \longrightarrow weakest

(c) Suggest why magnet A did not move when magnet X was placed at position 1. [1]

Score	3
-------	---

41 A measuring cylinder was filled with 40 ml of water at first.

Then a plastic ball was placed into the water and the observation is as shown.

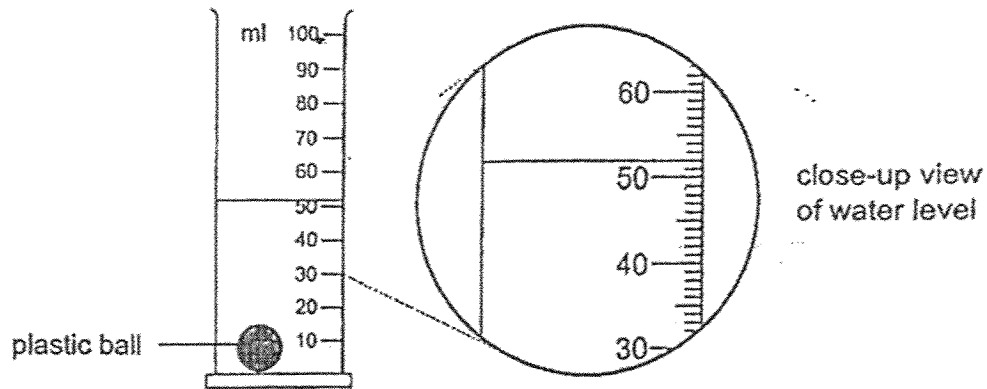

(a) What is the volume of the plastic ball?

[1]

Ted repeated the experiment by replacing the plastic ball with a metal ball of same size but greater mass.

He ensured that the initial water level of the measuring cylinder was still 40 ml.

(b) (i) Will the water level will be higher, lower or same when the metal ball is placed into the water?

[1]

(ii) Explain your answer.

[1]

Score	3
-------	---

(Go on to the next page)

- 42 Four rods, E, F, G and H, made from different materials were each coated with a thin layer of wax. One end of each rod was placed into a container of hot water as shown.

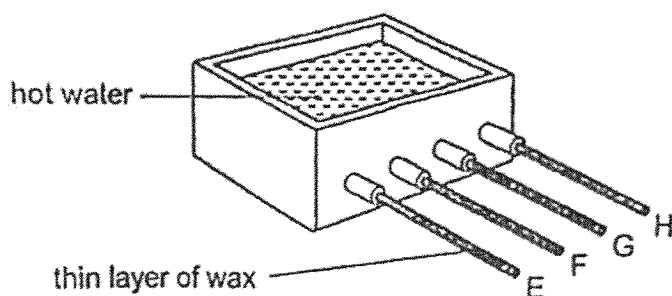

After 10 minutes, the length of wax left on each rod was measured and recorded in the table below.

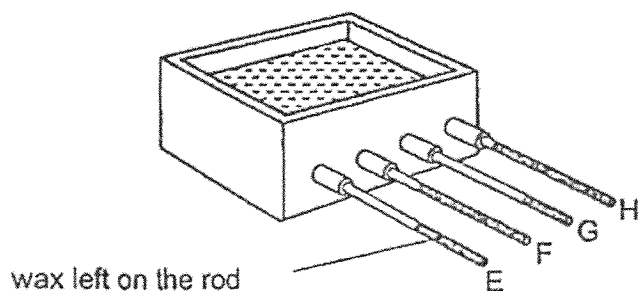

Rod	Length of wax left on the rod (cm)
E	5
F	7
G	3
H	9

- (a) State the source of heat in the experiment. [1]

- (b) Which rod is made of a material that is most suitable for making the base of a frying pan for cooking food? Explain your answer. [2]

In another experiment, each of the rods E, F, G and H was heated to 80°C , then left to hang in a classroom for 5 minutes. The temperature of each rod was measured every minute using an infrared thermometer.

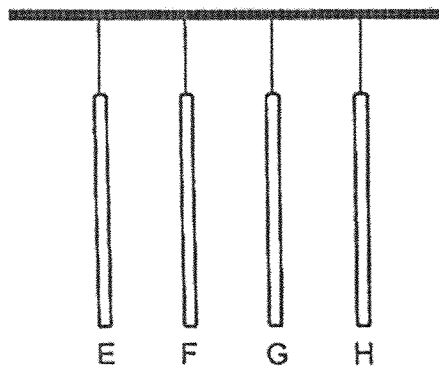

The graph below shows the changes in temperature over time for all four rods.

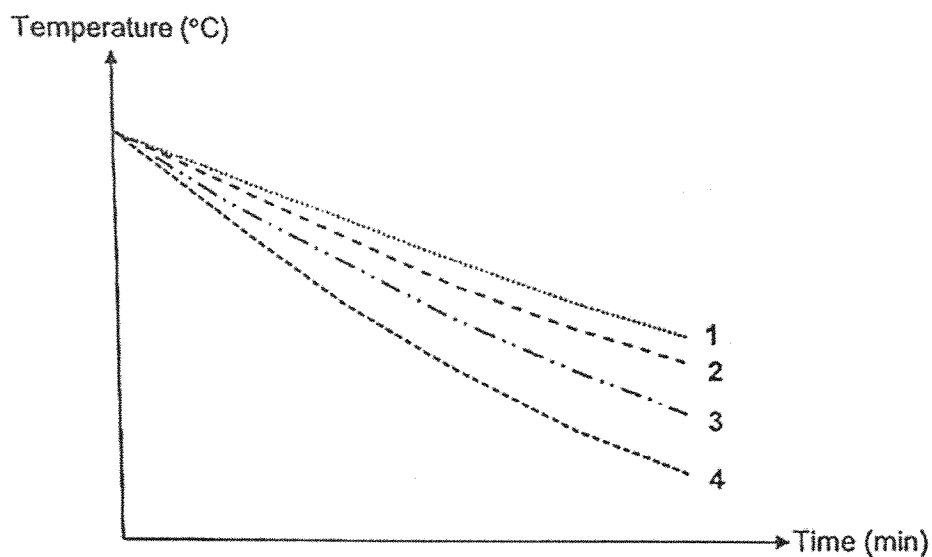

- (c) State which line on the graph, 1, 2, 3 or 4, represents the temperature change for rod H. [1]

Line _____

Score	4
-------	---

(Go on to the next page)

- 43 Sally set up an experiment in a dark room to find out how the number of sheets of material X affects the amount of light detected by the light sensor.

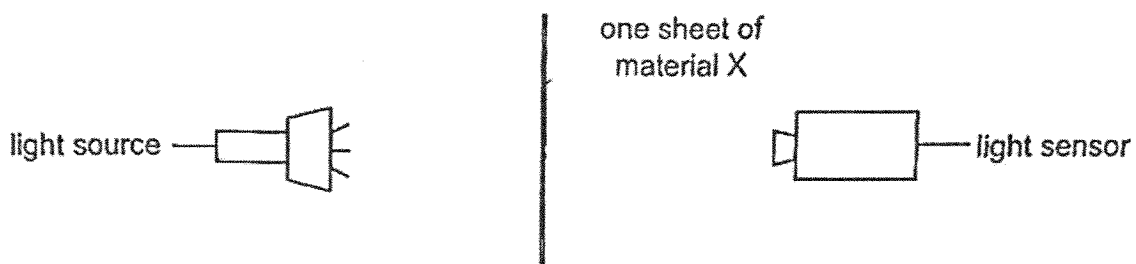

She repeated the experiment by increasing the number of sheets of material X and recorded the results in the table below.

Number of sheets of material X	Amount of light detected by light sensor (units)
0	120
1	82
2	43
3	2

- (a) State the variable that is changed in the experiment. [1]

- (b) State the property of material X shown by the experiment. [1]

- (c) Predict the amount of light detected by the light sensor when five sheets of material X are used. Explain your answer. [2]

End of Paper

Score	4
-------	---

SCHOOL : NAN HUA PRIMARY SCHOOL
LEVEL : PRIMARY 4
SUBJECT : SCIENCE
TERM : 2025 END OF YEAR EXAMINATION

Q1	Q2	Q3	Q4	Q5	Q6	Q7	Q8	Q9	Q10
4	2	4	4	3	2	2	2	3	4
Q11	Q12	Q13	Q14	Q15	Q16	Q17	Q18	Q19	Q20
1	3	3	1	4	2	1	4	3	1
Q21	Q22	Q23	Q24	Q25	Q26	Q27	Q28	Q29	Q30
2	3	2	2	1	2	4	3	3	3

31a	moist skin
31b	hair
32a	steel
32b	attracts
33a	solid
33b	liquid
34a	light, reflected
34b	Lamp shines light into Jack's eyes.
35a	decreases
35b	solid
36a	frog eggs
36bi	<p>Difference: The frog has 3 stages in its life cycle, but the mosquito has 4 stages in its life cycle.</p> <p>Similarity: Both the young of the frog and the mosquito do not resemble the adult. Both the frog and the mosquito lay eggs in the water.</p>
36bii	Cockroach / Grasshopper / Chicken
37a	<p>The smaller the size of food, the less the mass of the food left after one</p> <p>OR</p> <p>The bigger the size of food, the more the mass of the food left after one hour.</p>

37b	When the surface area of the food in contact with the digestive juices is greater, the rate of digestion is faster.
37c	S
38a	The plant needs to climb higher towards the sunlight to get more light to make more food.
38b	(i) True (ii) False (iii) Not possible to tell
39a	No. There is more than one type of material that will sink in the water.
39b	Block B is the only block that floats on water after 1 minute.
39c	Block A absorbed water.
40a	The like poles of magnet A and magnet W were facing each other, so they repelled.
40b	Y, Z, W, X
40c	Magnet X was too weak to repel magnet A.
41a	12 ml
41bi	Water level will be the same.
41bii	Metal ball has the same volume as the plastic ball.
42a	hot water
42b	C: G E: The length of wax left was the shortest. C: Material of rod G is the best conductor of heat as it conducts heat from the hot water to the wax the fastest. L: The food will gain heat the fastest.
42c	1
43a	Number of sheets of material X
43b	Translucent / allows some light to pass through
43c	0 There are too many sheets of material X, so no light can pass through.